

RICON® 160/40

Assemblage poteau - traverse

avec Avis Technique (EU + DE)

post and latch connection -

with construction supervisory approval (EU + DE)



<p>RICON 160/40</p>	<p>Vis RICON SK / RICON SK Scr 8x80</p>	<p>Vis tête fraisée, empreunte 6 pans / Countersunk socket screw M8x25, M8x20</p>
	<p>Vis RICON SK / RICON SK Scr 8x50</p>	<p>Entretoise / connecting nut M8x36, 48, 53, 58, 78</p>
	<p>Vis RICON SK / RICON SK Scr 5x80</p>	<p>Insert / insert screw M8x18</p>
	<p>Vis RICON SK / RICON SK Scr 5x50</p>	
	<p>Goupille de verrouillage / stirrup</p>	

Assemblage simple et doublé
Single and double connection

Assemblage poteau - traverse
Latch and post connection

Détails du fraisage traverse /
Milled edge latch

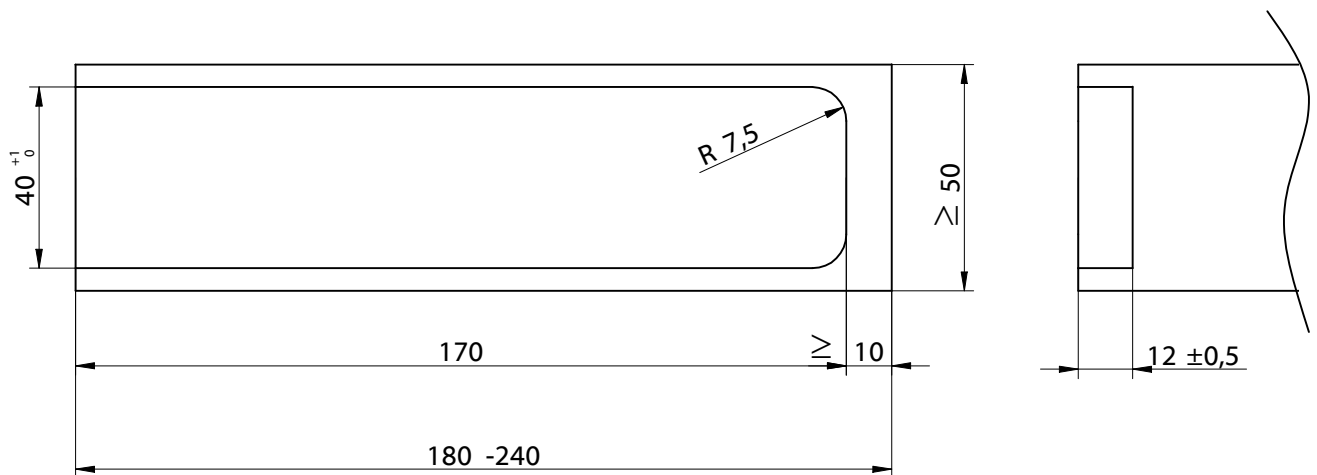

© KNAPP GmbH. Toutes dimensions en mm - sauf erreurs, fautes d'impression ou modifications techniques / all measures in mm - Errors excepted. VERSION 02 20.08.2010

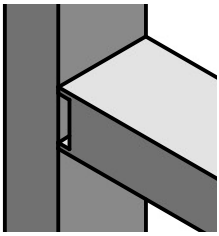

Notice de montage/Construction Manual

RICON® 160/40 EA

Assemblage simple
Single connection

Assemblage poteau - traverse
Latch and post connection

Réf. K364

Détail du perçage sur la traverse /
Drilling template for latch

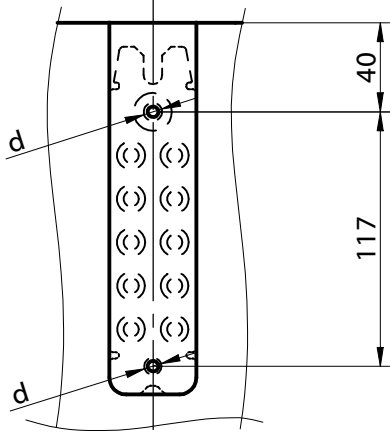

d...pré-percer Ø 5mm, prof. 30mm
d...Ø 5mm, 30mm deep predrilling

Détail du perçage sur le poteau /
Drilling template for post

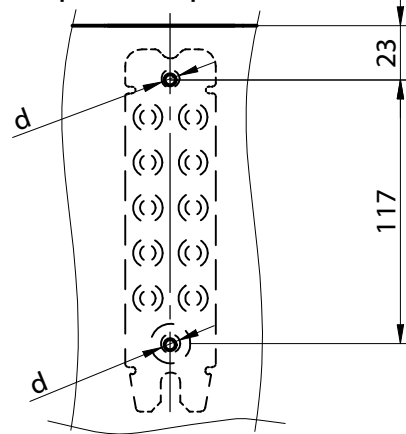

d...pré-percer Ø 5mm, prof. 30mm
d...Ø 5mm, 30mm deep predrilling

Détail du vissage sur la traverse /
screw template for latch

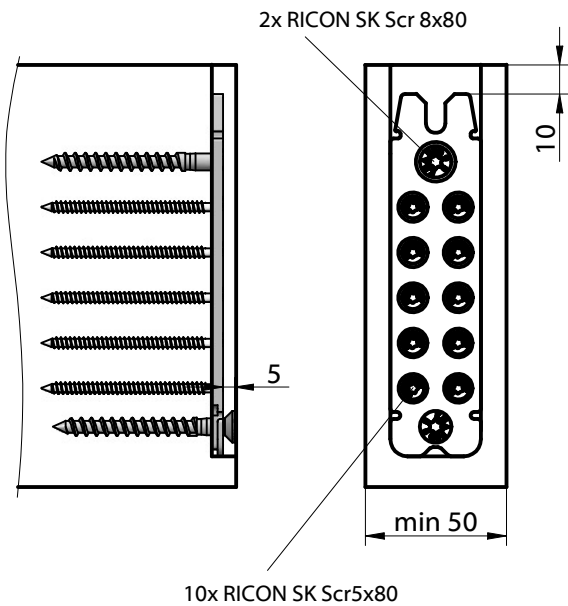

Détail du vissage sur le poteau /
Screw template for post

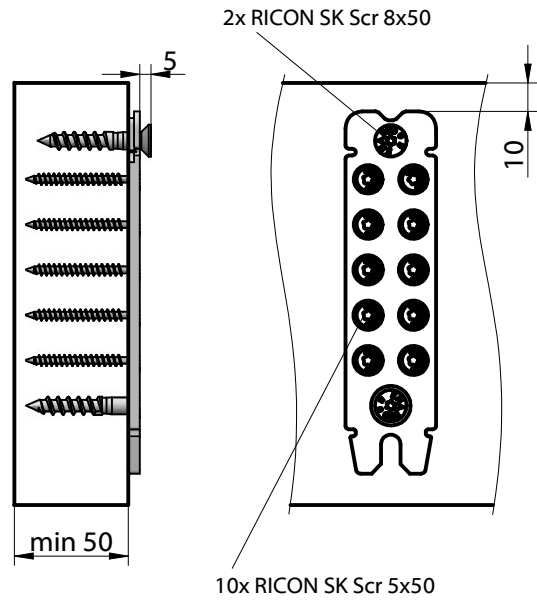

Régler la vis d'accroche /
Screw position adjustment

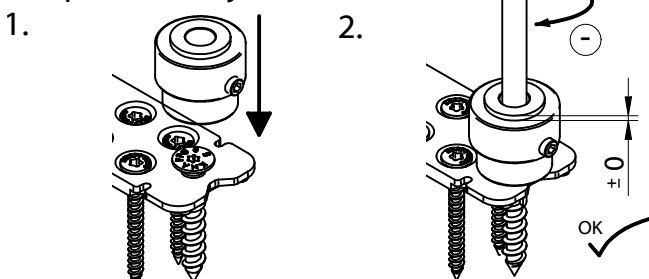

Mettre la goupille en place /
Assemble stirrup

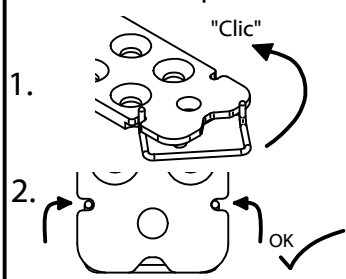

Déverrouiller la goupille /
Remove stirrup

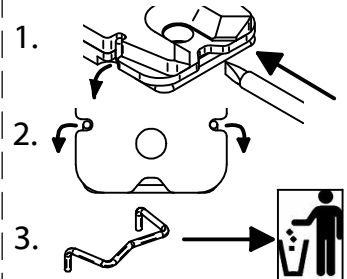

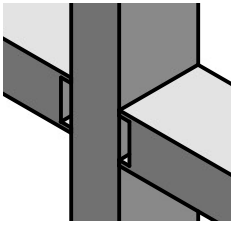

Notice de montage/Construction Manual

RICON® 160/40 DA

Réf. K164/48;
K164/58; K164/78

Assemblage doublé
Double connection

Assemblage poteau - traverse
Latch and post connection

Détail du perçage sur la traverse / Drilling template for latch

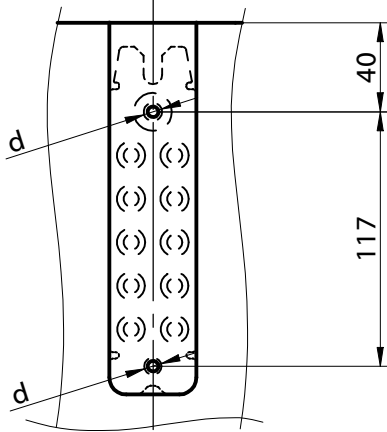

d...pré-percer Ø 5mm, prof. 30mm
d...Ø 5mm, 30mm deep predrilling

Détail du perçage sur le poteau / Drilling template for post

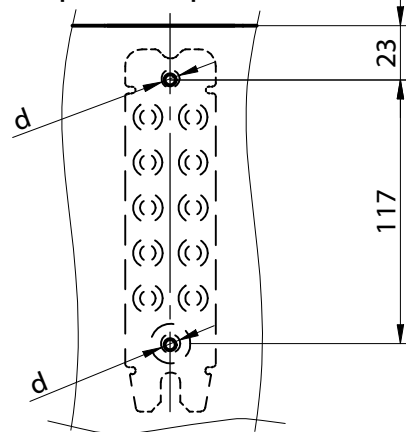

d...pré-percer en traversant Ø 10mm,
d...Ø 10mm, throughhole

Détail du vissage sur la traverse / screw template for latch

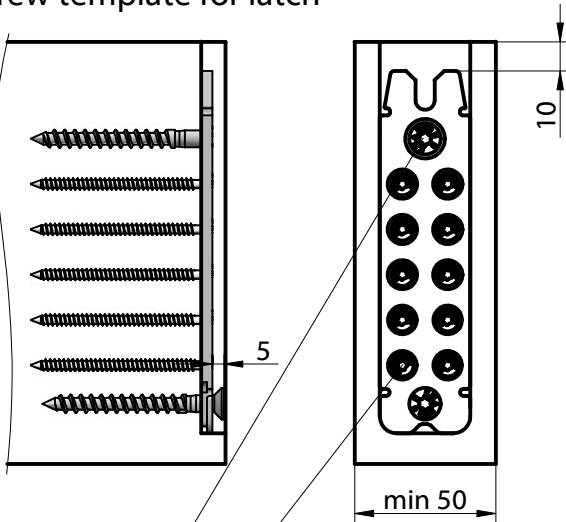

10x RICON SK Scr 5x80
2x RICON SK Scr 8x80

Détail du vissage sur le poteau / Screw template for post

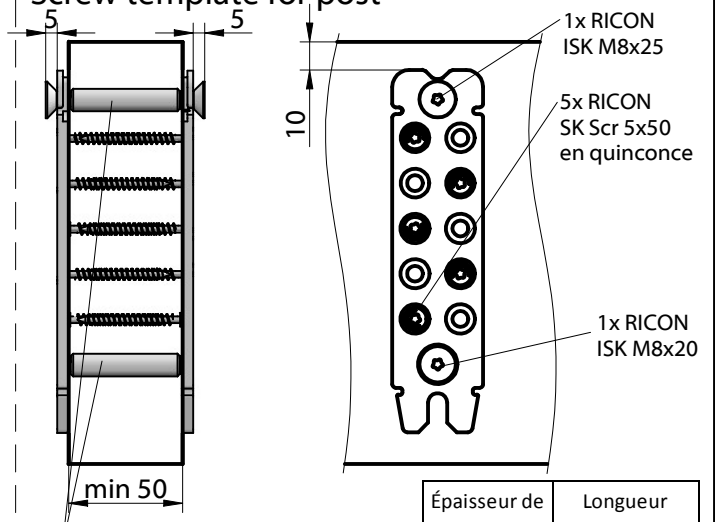

2 x Entretoises /
connecting nut
M8 x 36, 48, 53, 58
ou 78

Épaisseur de poteau [mm]	Longueur d'entretoise [mm]
50	48
56	53
60	58
80	78

Régler la vis d'accroche / Screw position adjustment

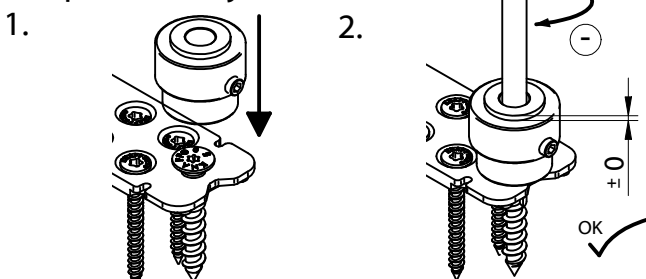

Mettre la goupille en place / Assemble stirrup

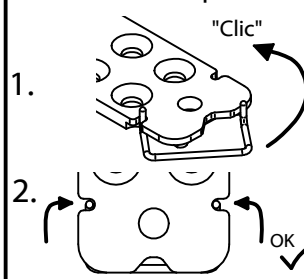

Déverrouiller la goupille / Remove stirrup

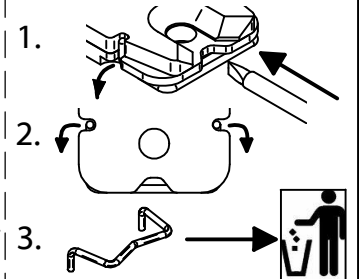

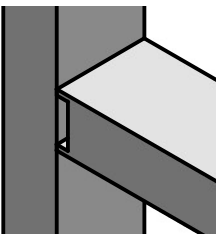

Notice de Montage/Construction Manual

RICON® 160/40 EAR

Réf. K264

Assemblage simple avec insert

Single connection with insert screw

Assemblage poteau - traverse

Latch and post connection

Détail du perçage sur la traverse /
Drilling template for latch

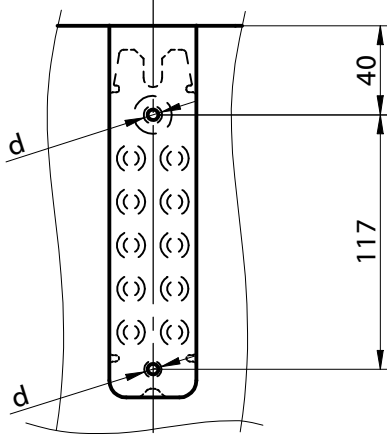

d...pré-percer Ø 5mm, prof. 30mm
d...Ø 5mm, 30mm deep predrilling

Détail du perçage sur le poteau /
Drilling template for post

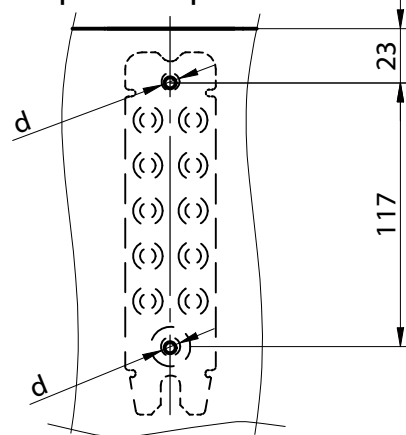

d...pré-percer Ø 12mm, prof. 20mm
d...Ø 12mm, 20mm deep predrilling

Détail du vissage sur la traverse /
screw template for latch

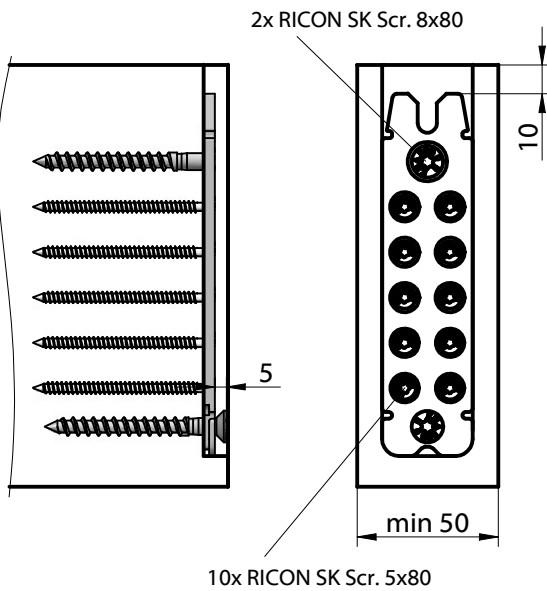

10x RICON SK Scr. 5x80

Détail du vissage sur le poteau /
Screw template for post

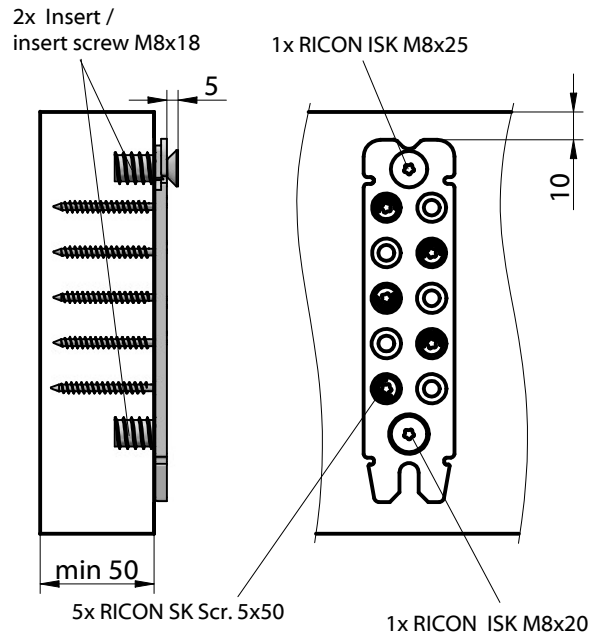

1x RICON ISK M8x20

Régler la vis d'accroche /
Screw position adjustment

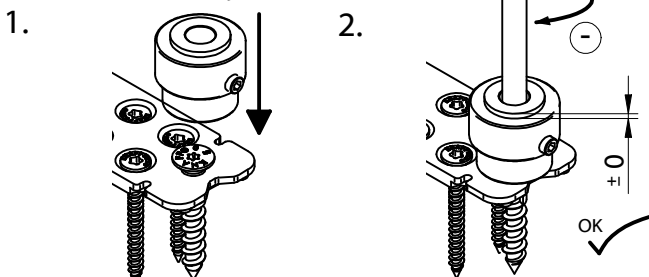

Mettre la goupille en place /
Assemble stirrup

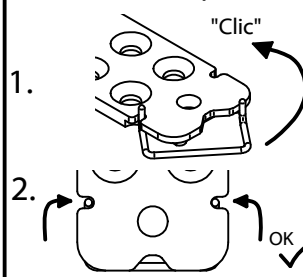

Déverrouiller la goupille /
Remove stirrup

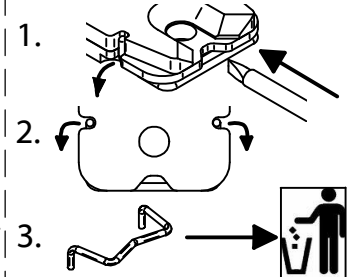

RICON® 160/40

Assemblage de poutre secondaire sur principale

- avec Avis Technique (EU + DE)

Main girder- joist connection

- with construction supervisory approval (EU + DE)



RICON 160/40

Vis RICON SK /
RICON SK Scr 8x80

Vis RICON SK/
RICON SK Scr 8x50

Vis RICON SK /
RICON SK Scr 5x80

Vis RICON SK /
RICON SK Scr 5x50

Goupille de verrouillage /
stirrup

Vis tête fraisée, emprunte 6 pans /
Countersunk socket screw
M8x25, M8x20

Entretoise/ connecting nut
M8x36, 48, 53, 58, 78

Insert / insert screw M8x18

Assemblage simple et doublé
Single and double connection

Poutre secondaire sur principale
Main girder - joist connection

Détails du fraisage poutre principale/ Milled edge main girder

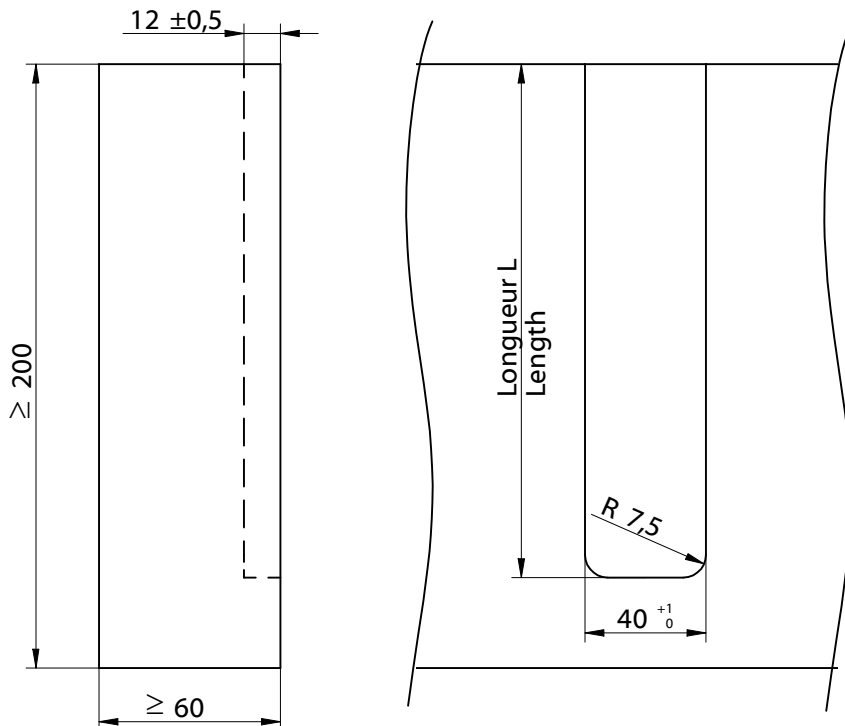

Long. de fraisage L sur pièce principale, en relation avec Ht. pièce secondaire HN / Rebate length for main girder in reference of the height HN of the joist:	
Hauteur / Height HN [mm]	Long. / Length L [mm]
200	180
220	190
240	200
260	210
280	230
300	240
320	260

© KNAPP GmbH. Toutes dimensions en mm - sauf erreurs, fautes d'impression ou modifications techniques / all measures in mm - Errors excepted. VERSION 02 20.08.2010

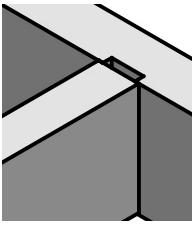

Notice de montage/Construction Manual

RICON® 160/40 EA

Assemblage simple
Single connection

Poutre secondaire sur principale
Main girder - joist connection

Réf. K364

Détail du perçage sur la poutre principale / Drilling template for main girder

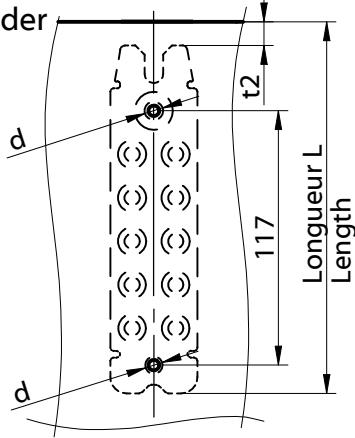

d...pré-percer Ø 5mm, prof. 30mm
d...Ø 5mm, 30mm deep predrilling

Détail du perçage sur la poutre secondaire / Drilling template for joist

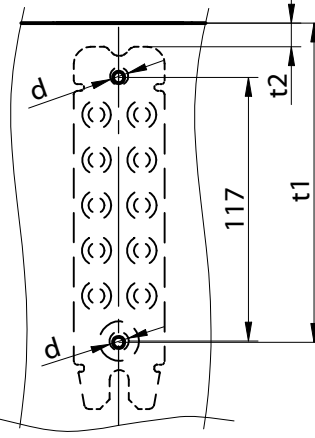

d...pré-percer Ø 5mm, prof. 30mm
d...Ø 5mm, 30mm deep predrilling

Distance de perçage t1 et t2, en relation avec la hauteur de la pièce secondaire HN / Bore measure t1 and distance t2 for joist in reference to the height HN of the joist

Hauteur / Height HN [mm]	Distance t1 [mm]	Distance t2 [mm]
200	150	20
220	160	30
240	170	40
260	180	50
280	200	70
300	210	80
320	230	100

Détail du vissage sur la poutre principale / Screw template for main girder

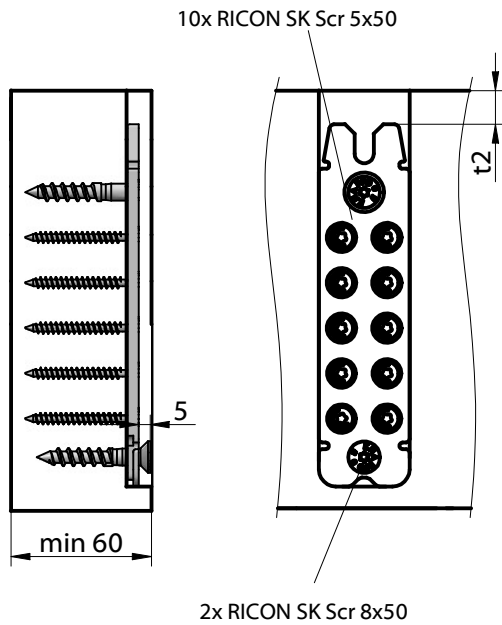

Détail du vissage sur la poutre secondaire / Screw template for joist

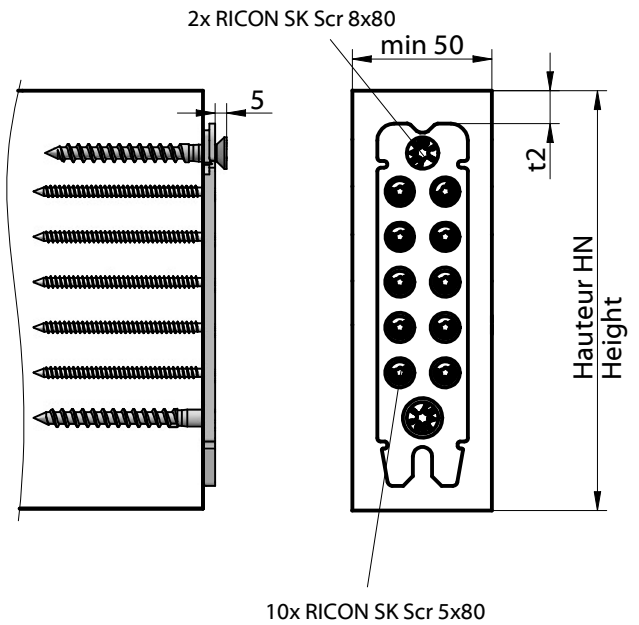

Régler la vis d'accroche / Screw position adjustment

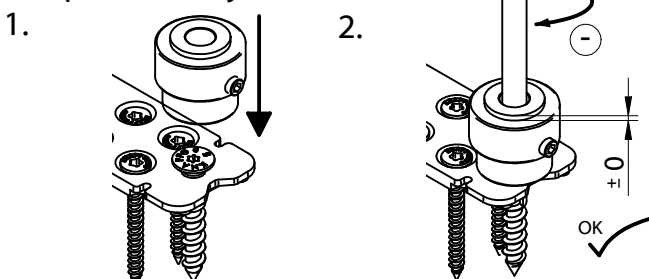

Mettre la goupille en place / Assemble stirrup

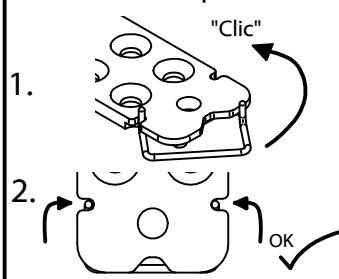

Déverrouiller la goupille / Remove stirrup

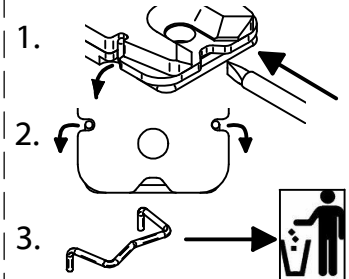

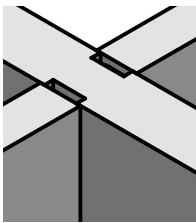

Notice de Montage/Construction Manual RICON® 160/40 DA

Réf. K164/48;
K164/58; K164/78

Assemblage doublé
Double connection

Poutre secondaire sur principale
Main girder - joist connection

Détail du perçage sur la poutre principale / Drilling template for main girder

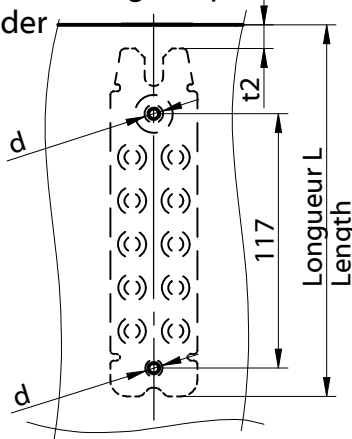

d...pré-percer en traversant Ø 10mm,
d...Ø 10mm, throughhole

Détail du perçage sur la poutre secondaire / Drilling template for joist

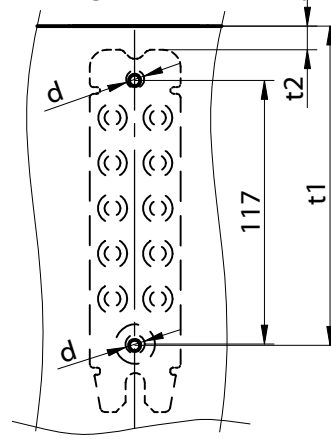

d...pré-percer Ø 5mm, prof. 30mm
d...Ø 5mm, 30mm deep predrilling

Distance de perçage t1 et t2, en relation avec la hauteur de la pièce secondaire HN / Bore measure t1 and distance t2 for joist in reference to the height HN of the joist

Hauteur / Height HN [mm]	Distance t1 [mm]	Distance t2 [mm]
200	150	20
220	160	30
240	170	40
260	180	50
280	200	70
300	210	80
320	230	100

Détail du vissage sur la poutre principale / Screw template for main girder

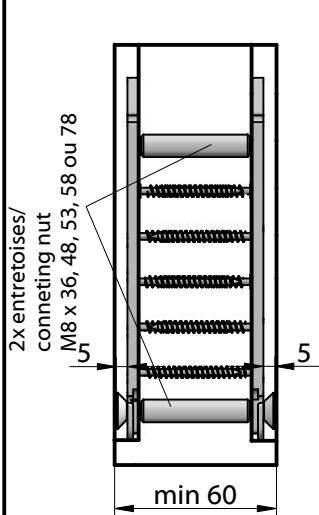

5x RICON SK Scr 5x50 en quinconce

Ép. de pièce principale [mm]	Longueur d'entretoise [mm]
60	36
80	53

Détail du vissage sur la poutre secondaire / Screw template for joist

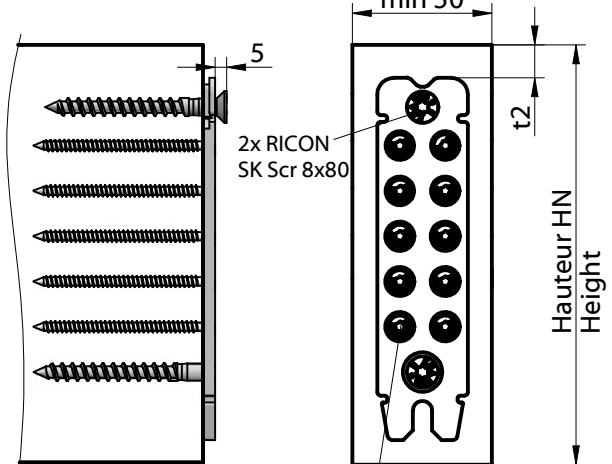

10x RICON SK Scr 5x80

Régler la vis d'accroche / Screw position adjustment

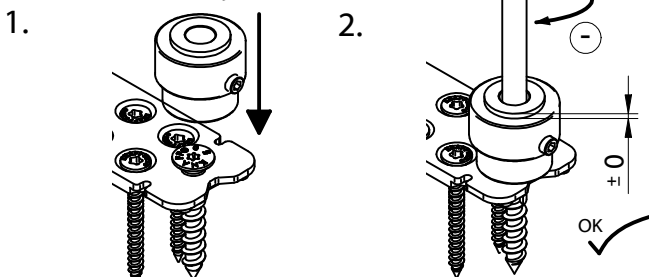

Mettre la goupille en place / Assemble stirrup

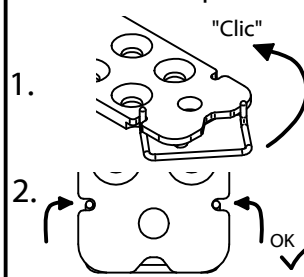

Déverrouiller la goupille / Remove stirrup

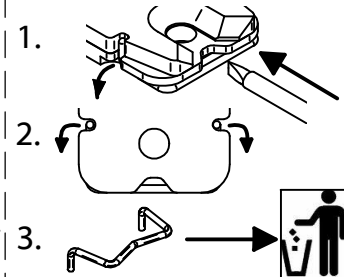

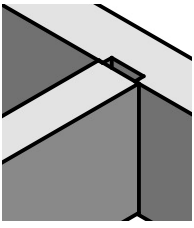

Notice de Montage/Construction Manual

RICON® 160/40 EAR

Assemblage simple avec insert Poutre secondaire sur principale
 Single connection with insert screw Main girder - joist connection

Réf. K264

Détail du perçage sur la poutre principale / Drilling template for main girder

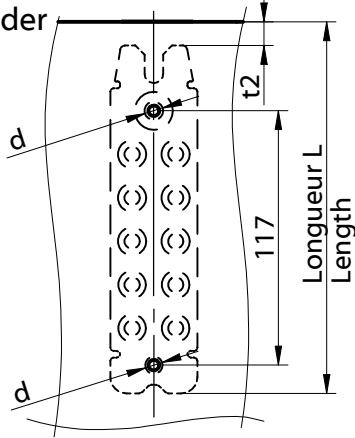

d...pré-percer Ø 12mm, prof. 20 mm
 d...Ø 12mm, 20 mm deep predrilling

Détail du perçage sur la poutre secondaire / Drilling template for joist

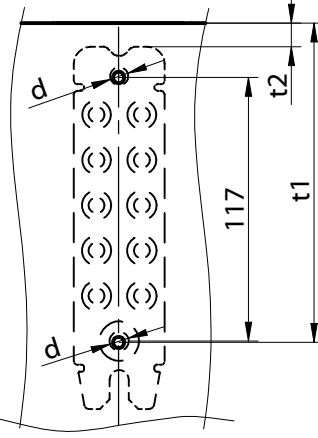

d...pré-percer Ø 5mm, prof. 30mm
 d...Ø 5mm, 30mm deep predrilling

Distance de perçage t1 et t2, en relation avec la hauteur de la pièce secondaire HN / Bore measure t1 and distance t2 for joist in reference to the height HN of the joist

Hauteur / Height HN [mm]	Distance t1 [mm]	Distance t2 [mm]
200	150	20
220	160	30
240	170	40
260	180	50
280	200	70
300	210	80
320	230	100

Détail du vissage sur la poutre principale / Screw template for main girder

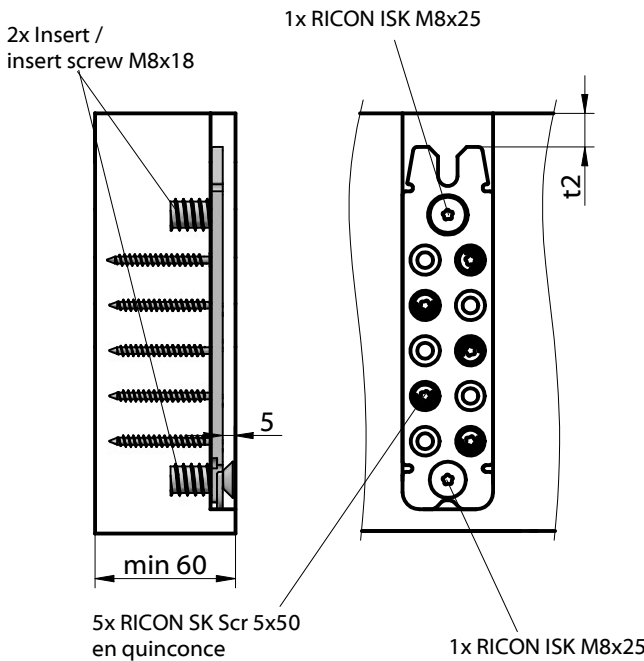

Détail du vissage sur la poutre secondaire / Screw template for joist

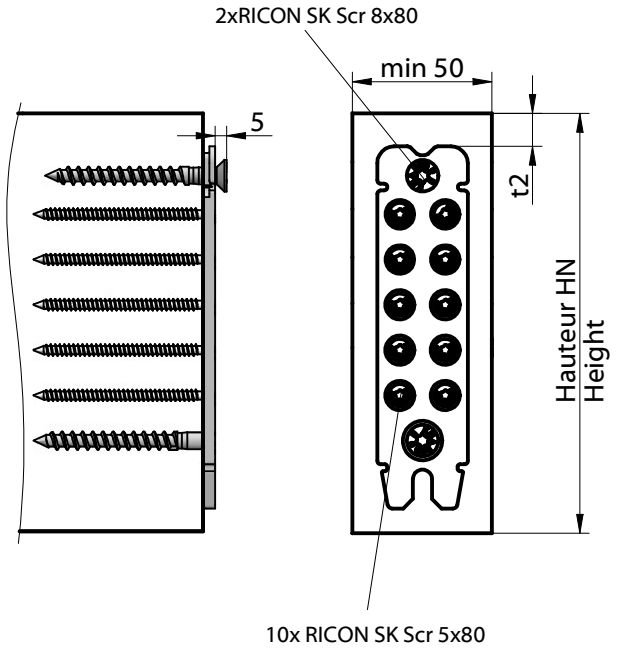

Régler la vis d'accroche / Screw position adjustment

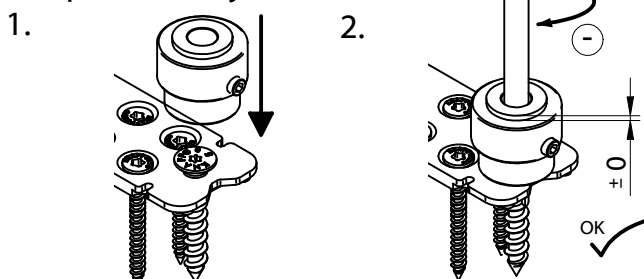

Mettre la goupille en place / Assemble stirrup

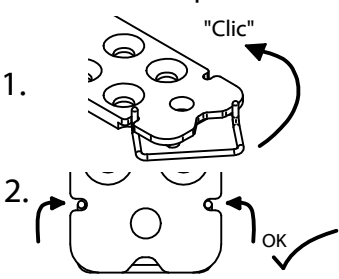

Déverrouiller la goupille / Remove stirrup

