

RICON® 80/40

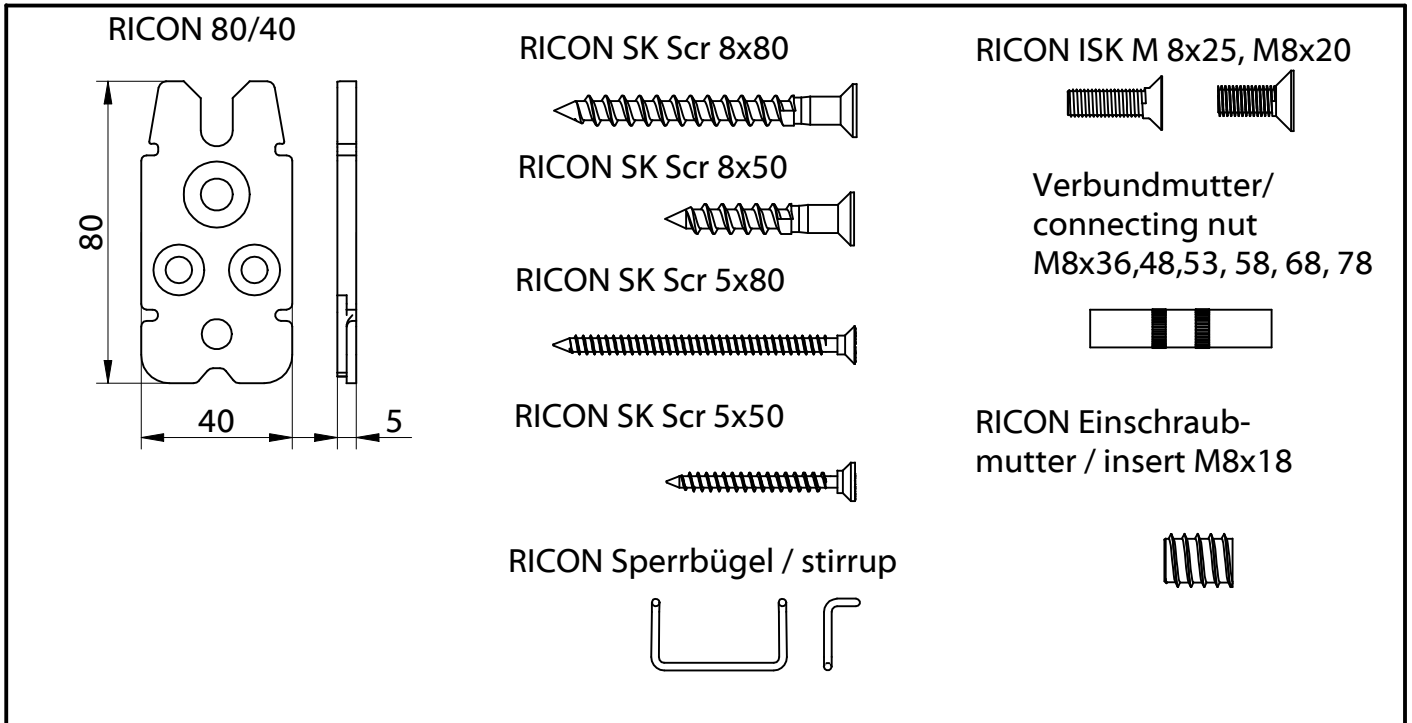

Pfosten-Riegelverbindung
mit Bauzulassung (DE+EU)
post and latch connection
with construction supervisory approval (DE+EU)



Einzel und Doppelanschluss
single and double connection

Pfosten-Riegelverbindung
latch and post connection

Riegel Fräsbild /
Milled edge latch

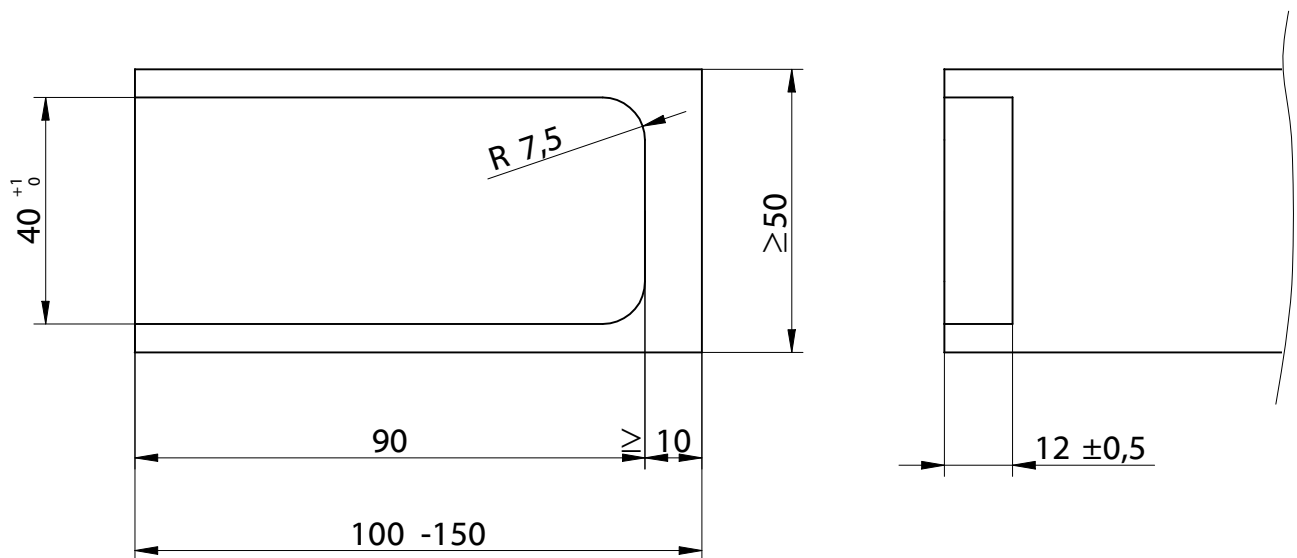

© KNAPP GmbH. Alle Maße in mm - Irrtümer, Druckfehler und Änderungen vorbehalten / all measures in mm - Errors excepted. VERSION 03 20.08.2010

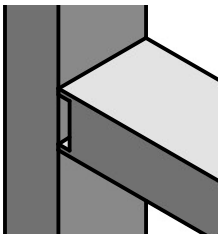

Montageanleitung/Construction Manual

RICON® 80/40 EA

Art. Nr. K361

**Einzelanschluss
single connection**

**Pfosten-Riegelverbindung
latch and post connection**

Bohrbild im Riegel /
drilling template for latch

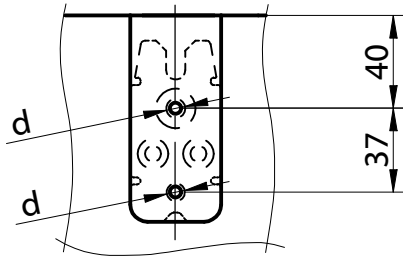

d...Ø 5mm, 30mm tief vorbohren
d...Ø 5mm, 30mm deep predrilling

Bohrbild im Pfosten /
drilling template for post

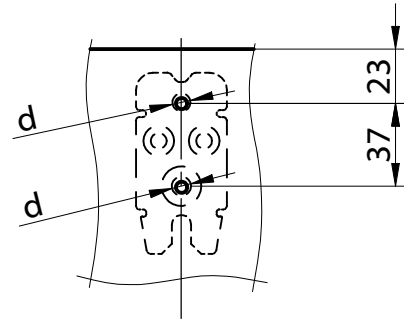

d...Ø 5mm, 30mm tief vorbohren
d...Ø 5mm, 30mm deep predrilling

Schraubenbild im Riegel /
screw template for latch

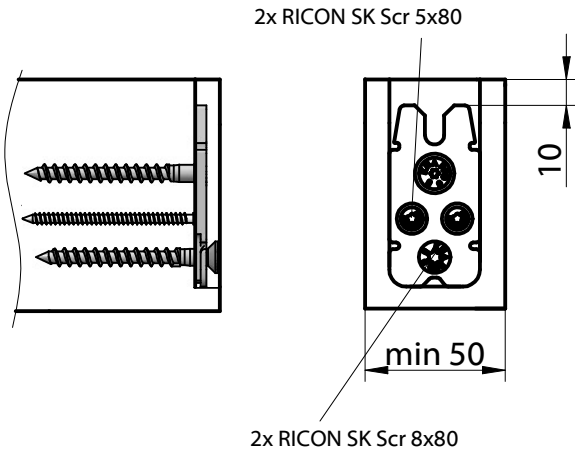

Schraubenbild im Pfosten /
screw template for post

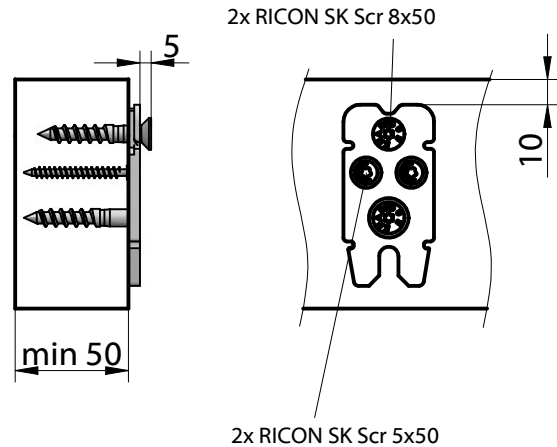

Einstellen der Schraube /
screw position adjustment

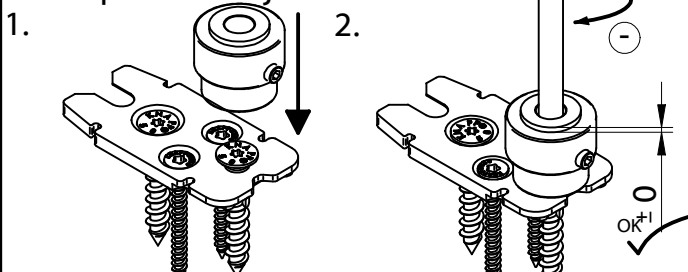

Sperrbügel einlegen /
assemble stirrup

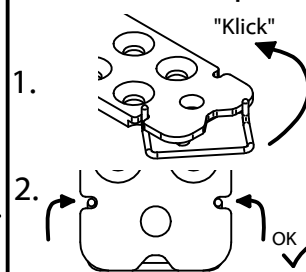

Sperrbügel lösen /
remove stirrup

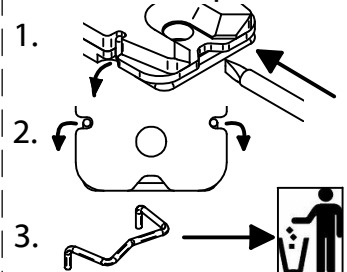

© KNAPP GmbH. Alle Maße in mm - Irrtümer, Druckfehler und Änderungen vorbehalten / all measures in mm - Errors excepted. VERSION 03 20.08.2010

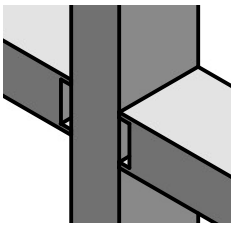

RICON® 80/40 DA

Art. Nr. K161/48;
K161/58; K161/78

Doppelanschluss
double connection

Pfosten-Riegelverbindung
latch and post connection

Bohrbild im Riegel /
drilling template for latch

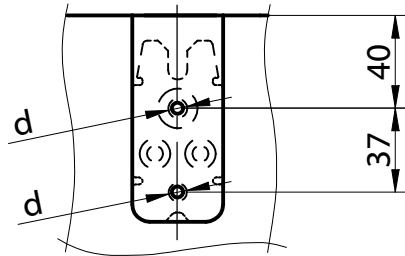

d...Ø 5mm, 30mm tief vorbohren
d...Ø 5mm, 30mm deep predrilling

Bohrbild im Pfosten /
drilling template for post

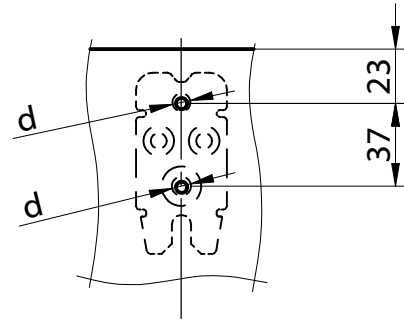

d...Ø 10mm, Durchgangsloch
d...Ø 10mm, throughhole

Schraubenbild im Riegel /
screw template for latch

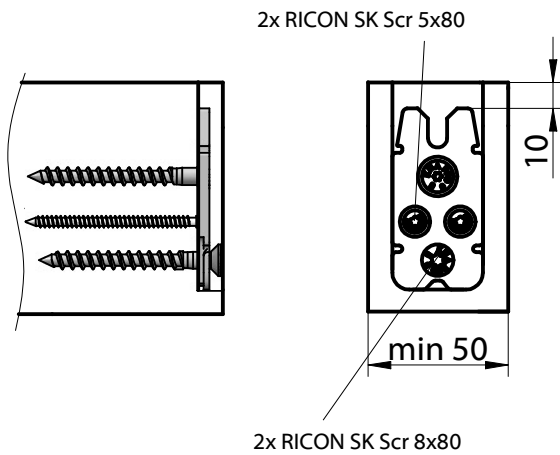

Schraubenbild im Pfosten /
screw template for post

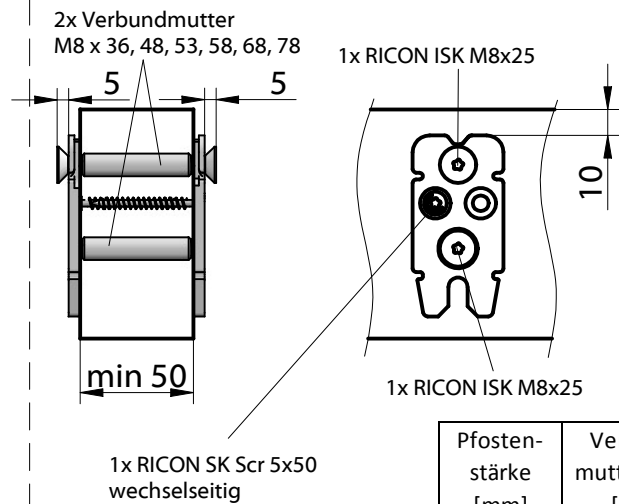

Einstellen der Schraube /
screw position adjustment

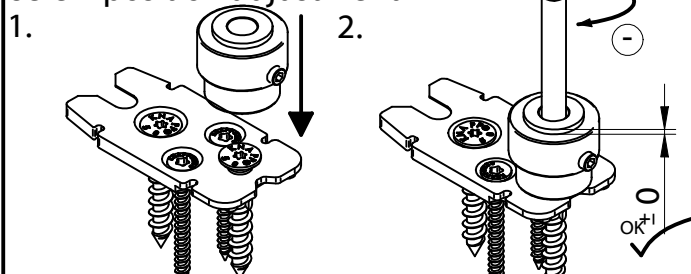

Sperrbügel einlegen /
assemble stirrup

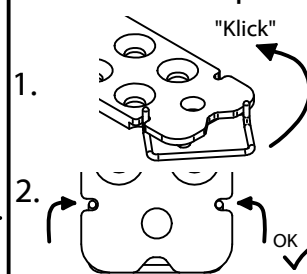

Sperrbügel lösen /
remove stirrup

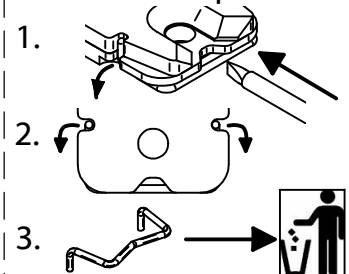

© KNAPP GmbH. Alle Maße in mm - Irrtümer, Druckfehler und Änderungen vorbehalten / all measures in mm - Errors excepted. VERSION 03 20.08.2010

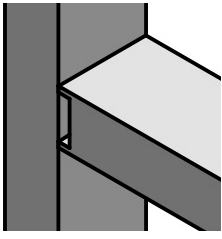

Montageanleitung/Construction Manual

RICON® 80/40 EAR

Art. Nr. K261 Einzelanschluss mit Einschraubmutter
single connection with insert screw

Pfosten-Riegelverbindung
post and latch connection

Bohrbild im Riegel /
drilling template for latch

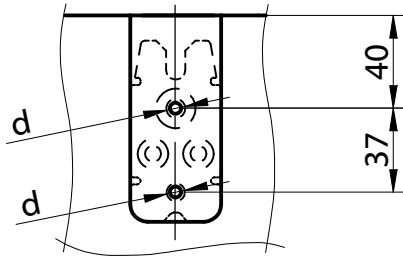

d...Ø 5mm, 30mm tief vorbohren
d...Ø 5mm, 30mm deep predrilling

Bohrbild im Pfosten /
drilling template for post

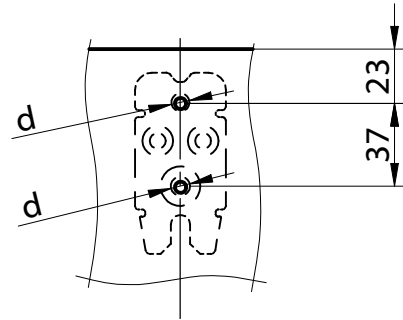

d...Ø 12 mm, 20 mm tief vorbohren
d...Ø 12 mm, 20mm deep predrilling

Schraubenbild im Riegel /
screw template for latch

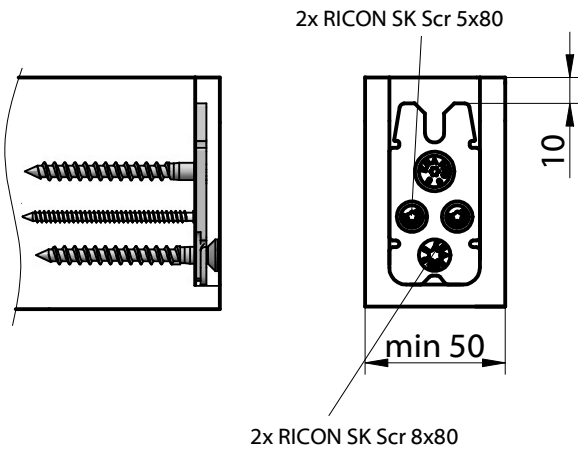

Schraubenbild im Pfosten /
screw template for post

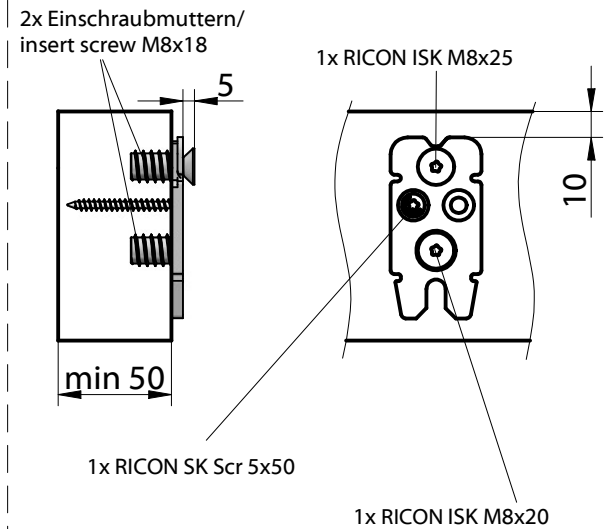

Einstellen der Schraube /
screw position adjustment

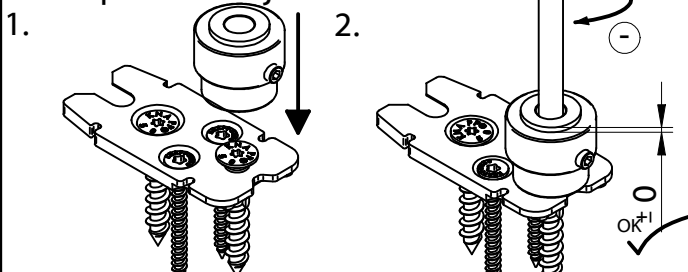

Sperrbügel einlegen /
assemble stirrup

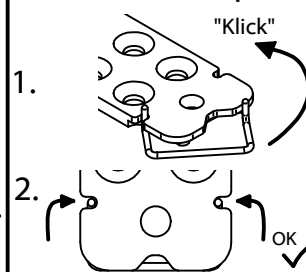

Sperrbügel lösen /
remove stirrup

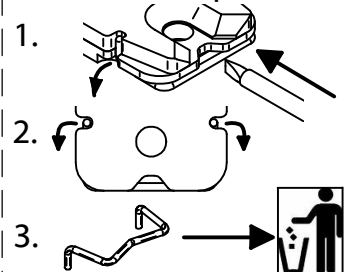

RICON® 80/40

Haupt- Nebenträgerverbindung

mit Bauzulassung (DE + EU)

main girder- joist connection

with construction supervisory approval (DE + EU)



RICON 80/40

RICON SK Scr 8x80

RICON SK Scr 8x50

RICON SK Scr 5x80

RICON SK Scr 5x50

RICON Sperrbügel / stirrup

RICON ISK M 8x25, M8x20

Verbundmutter/
connecting nut
M8x36,48,53, 58, 68, 78

RICON Einschraub-
mutter / insert M8x18

Einzel- und Doppelanschluss
single and double connection

Haupt-Nebenträgerverbindung
main girder - joist connection

Hauptträger Fräsbild /Milled edge main girder

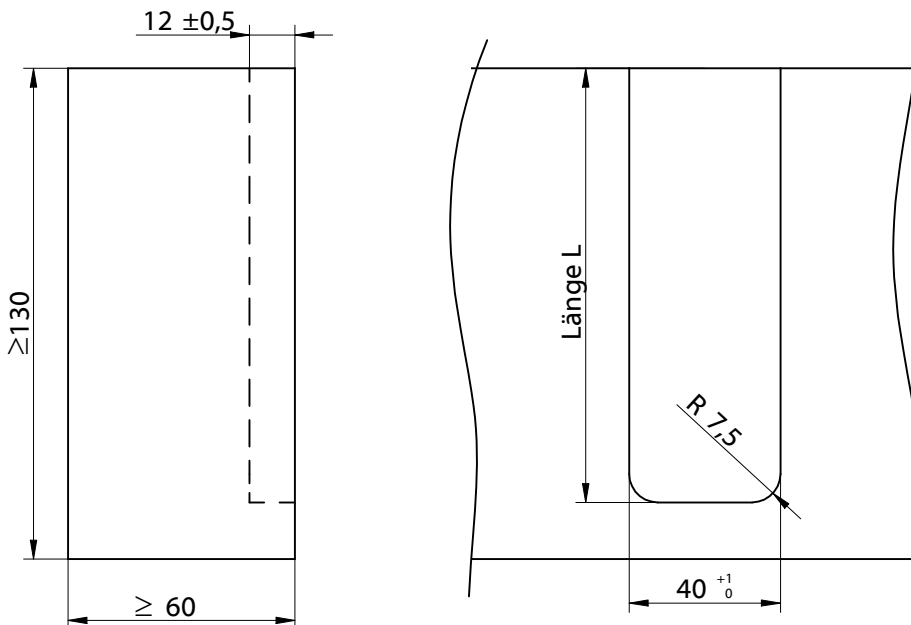

Ausfräslänge L aus dem Hauptträger in Abhängigkeit der Nebenträgerhöhe HN /
Rebate length for main girder in reference of the height HN of the joist:

Höhe / Height HN [mm]	Länge/ Length L [mm]
120	110
140	130
160	140

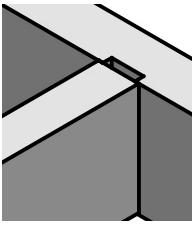

Montageanleitung/Construction Manual

RICON® 80/40 EA

Art. Nr. K361

Einzelanschluss
single connection

Haupt-Nebenträger Verbindung
main girder - joist connection

Bohrbild im Hauptträger /
drilling template for main girder

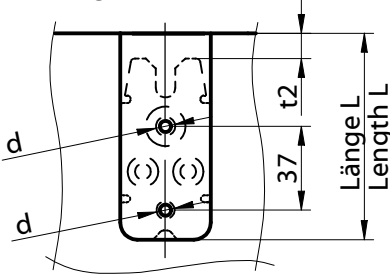

d...Ø 5mm, 30mm tief vorbohren
d...Ø 5mm, 30mm deep predrilling

Bohrbild im Nebenträger /
drilling template for joist

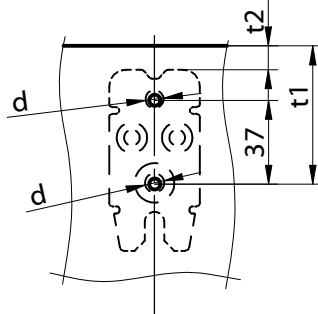

d...Ø 5mm, 30mm tief vorbohren
d...Ø 5mm, 30mm deep predrilling

Einbohrmaße t1 und Abstandsmaß t2 in
Abhängigkeit der Nebenträgerhöhe HN/
Bore measure t1 and distance t2 for joist in
reference to the height HN of the joist

Höhe / Height HN [mm]	Abstand/ Distance t1 [mm]	Abstand/ Distance t2 [mm]
120	80	30
140	100	50
160	110	60

Schraubenbild im Hauptträger /
screw template for main girder

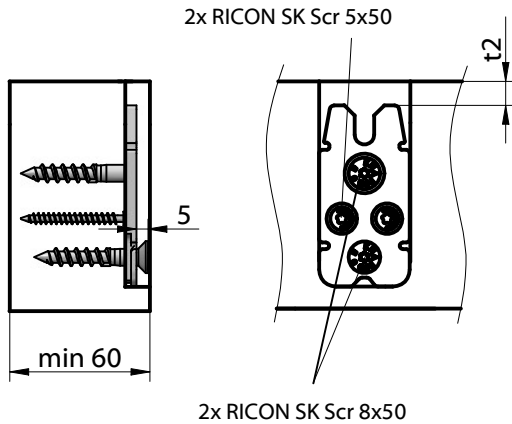

Schraubenbild im Nebenträger /
screw template for joist

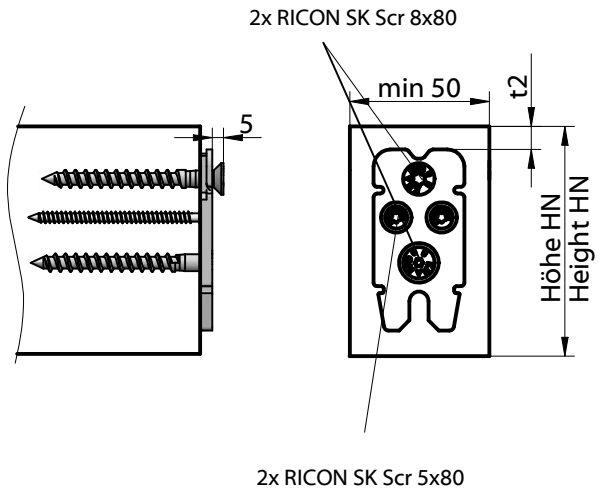

Einstellen der Schraube /
screw position adjustment

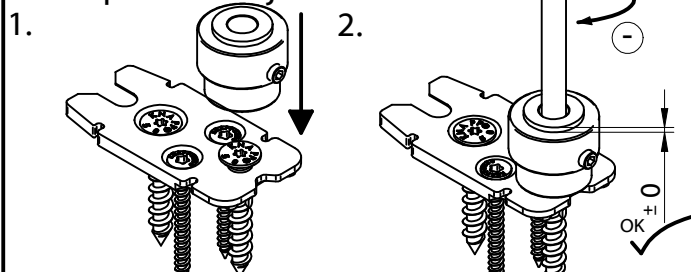

Sperrbügel einlegen /
assemble stirrup

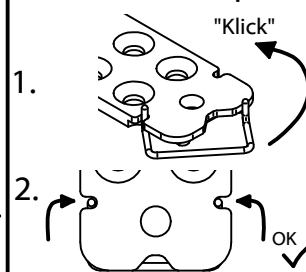

Sperrbügel lösen /
remove stirrup

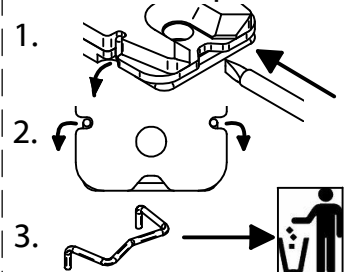

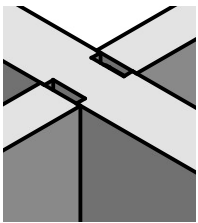

Montageanleitung/Construction Manual

RICON® 80/40 DA

Art. Nr. K161/48;
K161/58; K161/78

Doppelanschluss
double connection

Haupt-Nebenträger Verbindung
main girder - joist connection

Bohrbild im Hauptträger /
drilling template for main girder

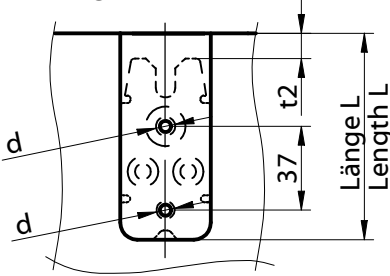

Bohrbild im Nebenträger /
drilling template for joist

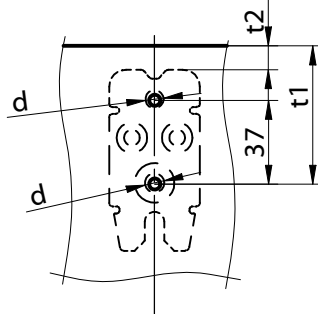

Einbohrmaße t1 und Abstandsmaß t2 in
Abhängigkeit der Nebenträgerhöhe HN/
Bore measure t1 and distance t2 for joist in
reference to the height HN of the joist

Höhe / Height HN [mm]	Abstand/ Distance t1 [mm]	Abstand/ Distance t2 [mm]
120	80	30
140	100	50
160	110	60

d...Ø 10mm, Durchgangsloch
d...Ø 10mm, throughhole

d...Ø 5mm, 30mm tief vorbohren
d...Ø 5mm, 30mm deep predrilling

Schraubenbild im Hauptträger /
screw template for main girder

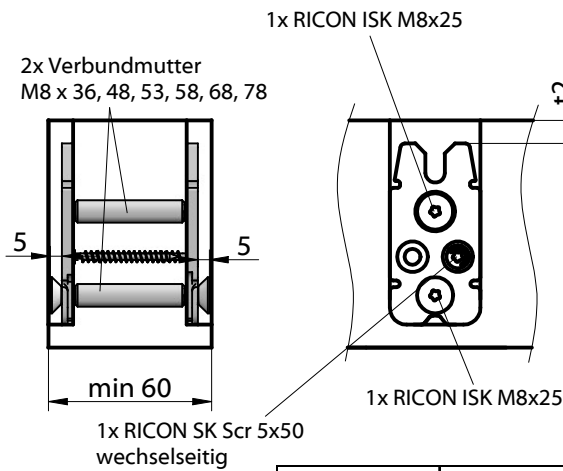

Hauptträger- stärke [mm]	Verbund- mutterlänge [mm]
60	36
80	53

Schraubenbild im Nebenträger /
screw template for joist

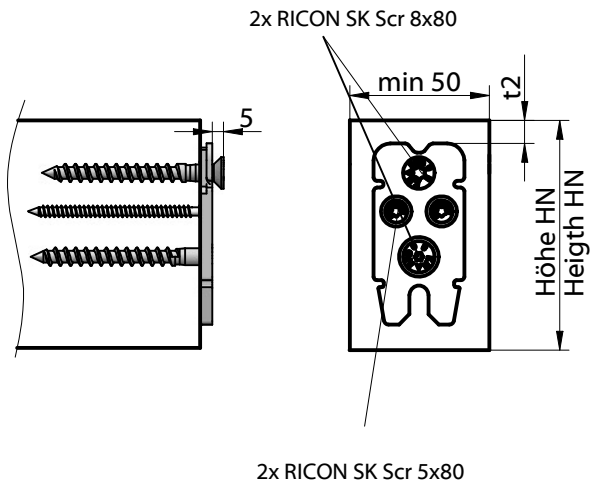

Einstellen der Schraube /
screw position adjustment

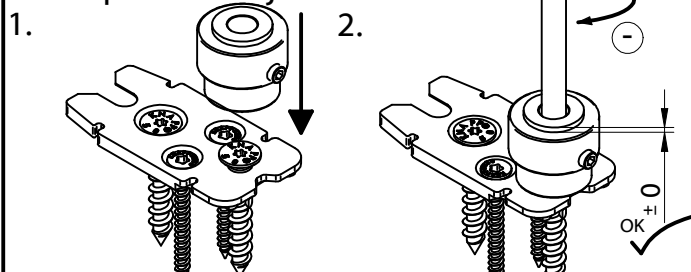

Sperrbügel einlegen /
assemble stirrup

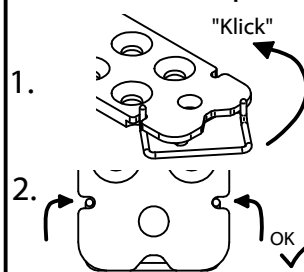

Sperrbügel lösen /
remove stirrup

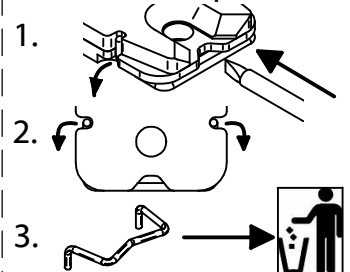

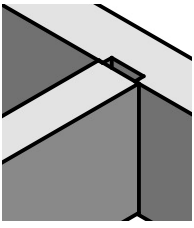

Montageanleitung/Construction Manual

RICON® 80/40 EAR

Art. Nr. K261

Einzelanschluss mit Einschraubmutter
single connection with insert screw

Haupt-Nebenträger Verbindung
main girder - joist connection

Bohrbild im Hauptträger /
drilling template for main girder

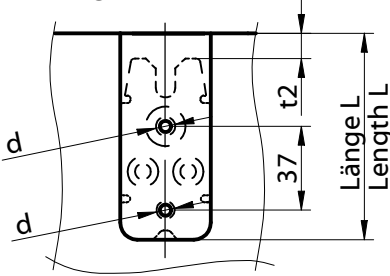

Bohrbild im Nebenträger /
drilling template for joist

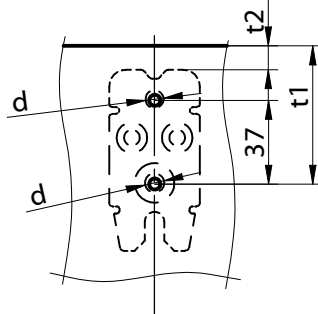

Einbohrmaße t1 und Abstandsmaß t2 in
Abhängigkeit der Nebenträgerhöhe HN/
Bore measure t1 and distance t2 for joist in
reference to the height HN of the joist

Höhe / Height HN [mm]	Abstand/ Distance t1 [mm]	Abstand/ Distance t2 [mm]
120	80	30
140	100	50
160	110	60

d...Ø 12 mm, 20 mm tief vorbohren
d...Ø 12 mm, 20 mm deep predrilling

d...Ø 5 mm, 30mm tief vorbohren
d...Ø 5 mm, 30mm deep predrilling

Schraubenbild im Hauptträger /
screw template for main girder

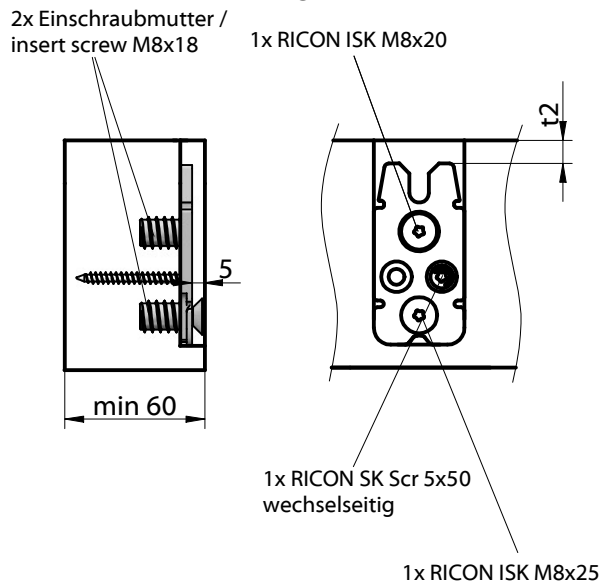

Schraubenbild im Nebenträger /
screw template for joist

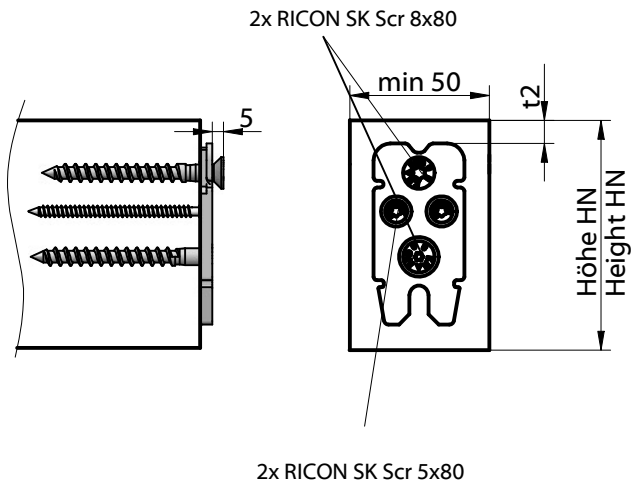

Einstellen der Schraube /
screw position adjustment

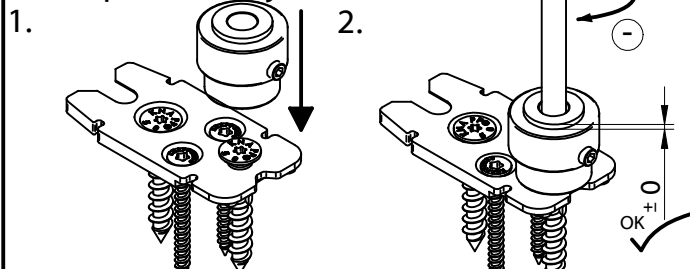

Sperrbügel einlegen /
assemble stirrup

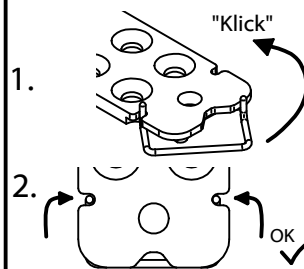

Sperrbügel lösen /
remove stirrup

