

## Schlüsseltaster SCT

## Key-operated switch SCT

120527-03

DE Montageanleitung  
GB Installation instructions



**Germany**  
GEZE Sonderkonstruktionen GmbH  
Planken 1  
97944 Boxberg-Schweigern  
Tel. +49 (0) 7930 9294 0  
Fax +49 (0) 7930 9294 10  
E-Mail: sk.de@geze.com  
GEZE GmbH  
Niederlassung Süd-West  
Tel. +49 (0) 7152 203 594  
E-Mail: leonberg.de@geze.com  
GEZE GmbH  
Niederlassung Süd-Ost  
Tel. +49 (0) 7152 203 6440  
E-Mail: muenchen.de@geze.com  
GEZE GmbH  
Niederlassung Ost  
Tel. +49 (0) 7152 203 6840  
E-Mail: berlin.de@geze.com  
GEZE GmbH  
Niederlassung Mitte/Luxemburg  
Tel. +49 (0) 7152 203 6888  
E-Mail: frankfurt.de@geze.com  
GEZE GmbH  
Niederlassung West  
Tel. +49 (0) 7152 203 6770  
E-Mail: essen.de@geze.com  
GEZE GmbH  
Niederlassung Nord  
Tel. +49 (0) 7152 203 6600  
E-Mail: hamburg.de@geze.com  
GEZE Service GmbH  
Tel. +49 (0) 1802 923392  
E-Mail: service-info.de@geze.com

**Austria**  
GEZE Austria  
E-Mail: austria.at@geze.com  
www.geze.at  
**Baltic States**  
GEZE GmbH Baltic States office  
E-Mail: office-latvia@geze.com  
www.geze.com  
**Benelux**  
GEZE Benelux B.V.  
E-Mail: benelux.nl@geze.com  
www.geze.be  
www.geze.nl  
**Bulgaria**  
GEZE Bulgaria - Trade  
E-Mail: office-bulgaria@geze.com  
www.geze.bg

**China**  
GEZE Industries (Tianjin) Co., Ltd.  
E-Mail: chinasales@geze.com.cn  
www.geze.com.cn  
GEZE Industries (Tianjin) Co., Ltd.  
Branch Office Shanghai  
E-Mail: chinasales@geze.com.cn  
www.geze.com.cn  
GEZE Industries (Tianjin) Co., Ltd.  
Branch Office Guangzhou  
E-Mail: chinasales@geze.com.cn  
www.geze.com.cn  
GEZE Industries (Tianjin) Co., Ltd.  
Branch Office Beijing  
E-Mail: chinasales@geze.com.cn  
www.geze.com.cn

**France**  
GEZE France S.A.R.L.  
E-Mail: france.fr@geze.com  
www.geze.fr

**Hungary**  
GEZE Hungary Kft.  
E-Mail: office-hungary@geze.com  
www.geze.hu

**Iberia**  
GEZE Iberia S.R.L.  
E-Mail: info@geze.es  
www.geze.es

**India**  
GEZE India Private Ltd.  
E-Mail: office-india@geze.com  
www.geze.in

**Italy**  
GEZE Italia S.r.l.  
E-Mail: italia.it@geze.com  
www.geze.it

GEZE Engineering Roma S.r.l.  
E-Mail: roma@geze.biz  
www.geze.it

**Poland**  
GEZE Polska Sp. z o.o.  
E-Mail: geze.pl@geze.com  
www.geze.pl

**Romania**  
GEZE Romania S.R.L.  
E-Mail: office-romania@geze.com  
www.geze.ro

**Russia**  
OOO GEZE RUS  
E-Mail: office-russia@geze.com  
www.geze.ru

**Scandinavia – Sweden**  
GEZE Scandinavia AB  
E-Mail: sverige.se@geze.com  
www.geze.se

**Scandinavia – Norway**  
GEZE Scandinavia AB avd. Norge  
E-Mail: norge.se@geze.com  
www.geze.no

**Scandinavia – Denmark**  
GEZE Danmark  
E-Mail: danmark.se@geze.com  
www.geze.dk

**Singapore**  
GEZE (Asia Pacific) Pte, Ltd.  
E-Mail: gezessea@geze.com.sg  
www.geze.com

**South Africa**  
GEZE Distributors (Pty) Ltd.  
E-Mail: info@gezesa.co.za  
www.geze.co.za

**Switzerland**  
GEZE Schweiz AG  
E-Mail: schweiz.ch@geze.com  
www.geze.ch

**Turkey**  
GEZE Kapi ve Pencere Sistemleri  
E-Mail: office-turkey@geze.com  
www.geze.com

**Ukraine**  
LLC GEZE Ukraine  
E-Mail: office-ukraine@geze.com  
www.geze.ua

**United Arab Emirates/GCC**  
GEZE Middle East  
E-Mail: gezeme@geze.com  
www.geze.ae

**United Kingdom**  
GEZE UK Ltd.  
E-Mail: info.uk@geze.com  
www.geze.com

## GEZE GmbH

Reinhold-Vöster-Straße 21–29 Tel.: 0049 7152 203 0  
71229 Leonberg Fax: 0049 7152 203 310  
Germany www.geze.com



## Bezeichnung / Description

- Schlüsseltaster, 1 pol. mit 1-fach Rahmen AS 500 alpinweiß, ohne Profilhalbzylinder, Mat. Nr. 117996
- Key-operated switch, single-pole with 1 frame AS 500 alpine white, without profile half cylinder, Mat. No. 117996

## Zubehör / Accessories

| Name  | Mat. Nr. |
|---|----------|
| AS 500 UP-Rahmen / AS 500 concealed frame   |          |
| ▫ 1-fach / single   | 115376   |
| ▫ 2-fach / double   | 115377   |
| ▫ 3-fach / triple   | 115378   |
| ▫ 4-fach / quadruple  | 115379   |
| ▫ 5-fach / quintuple  | 115380   |
| AS 500 Aufputzdose / AS 500 surface-mounted box   |          |
| ▫ 1-fach / single   | 120503   |
| ▫ 2-fach / double   | 128609   |
| ▫ 3-fach / triple   | 133206   |
| Zwischenrahmen 55x55 für ST 550 alpinweiß / intermediate frame 55x55 for ST 550 alpine white    | 155851   |
| Zwischenrahmen 55x55 für LS 990 alpinweiß / intermediate frame 55x55 for LS 990 alpine white    | 148997   |
| Zwischenrahmen 55x55 für LS 990 edelstahl / intermediate frame 55x55 for LS 990 stainless steel | 131822   |
| AS 500 Blindabdeckung BAB / AS 500 dummy cover BAB  | 118480   |
| Profilhalbzylinder / profile half cylinder  | 090176   |
| Schaltkontakt / switch contact  | 024467   |

## Passende Schalterprogramme / Matching switch ranges

- |   |               |
|---|---------------|
| <b>Jung</b>   | <b>Gira</b>   |
| ▫ AS 500  | ▫ Standard 55 |
| ▫ LS 990 (mit Zwischenrahmen / with intermediate frame) | ▫ E2          |
| ▫ ST550 (mit Zwischenrahmen / with intermediate frame)  | ▫ Event       |
|   | <b>Feller</b> |
|   | ▫ EDIZIOdue   |

## Merten

- System M

## Berker

- B3
- B7
- S1

## Technische Daten / Technical data

- |                                       |               |
|---------------------------------------|---------------|
| ▫ Schaltspannung / Switching voltage: | max. 240 V AC |
| ▫ Schaltstrom / Switching current:    | max. 4 A      |
| ▫ Schutzart / Protection rating:      | IP 40         |

# Normen / Standards

▫ DIN 18 252 - Profilzylinder für Türschlösser / profile cylinder for door locks

# Maßzeichnungen / Dimensional drawings

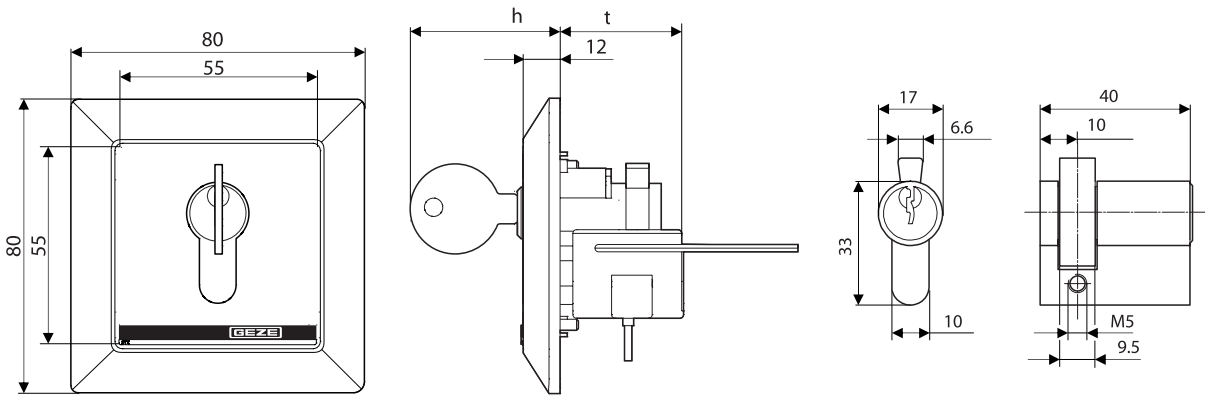

# Zusammenbau / Assembly

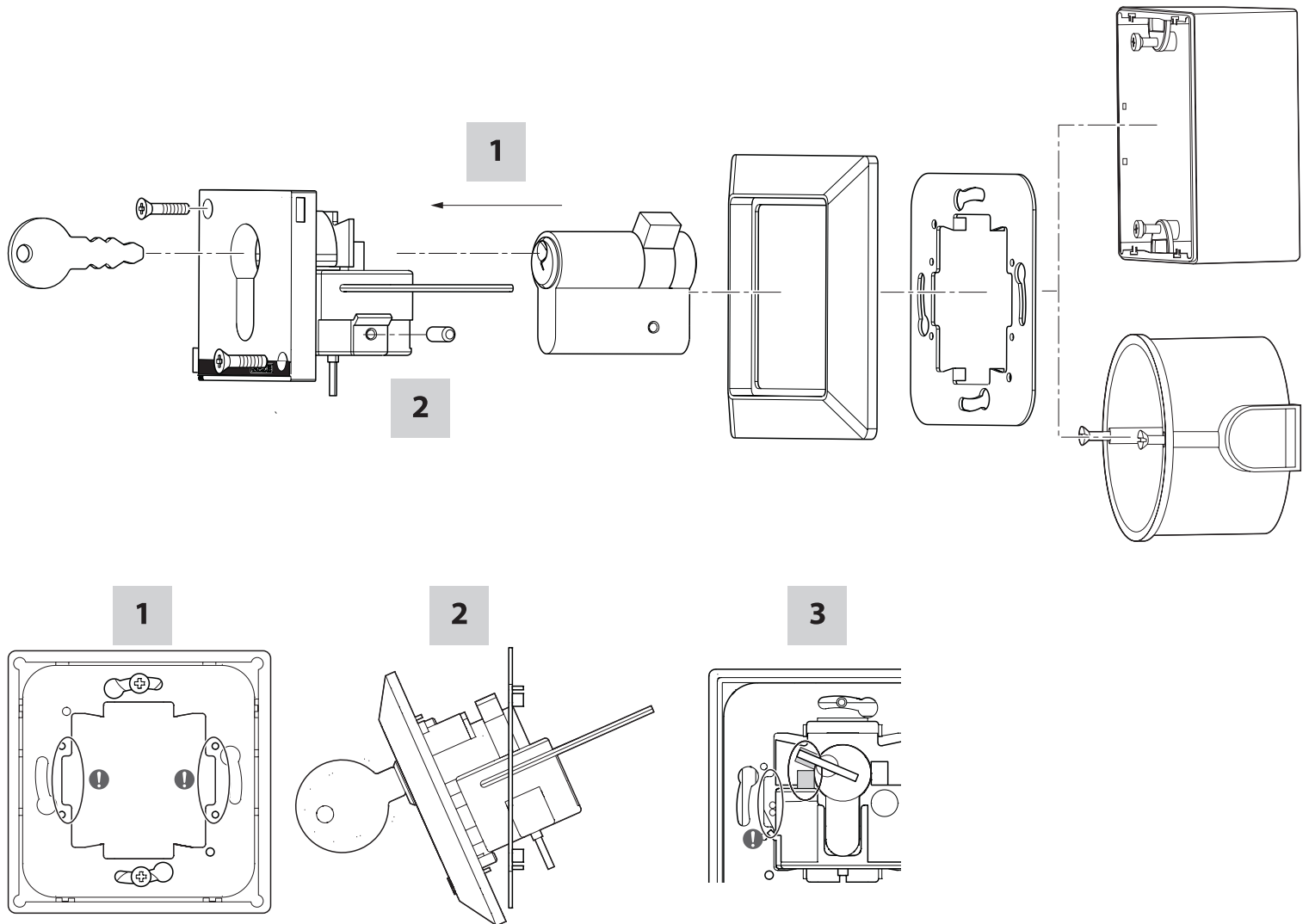

# Schablone für Pfostenmontage / Template for installation on a post



Die Papierschablone kann sich abhängig von der Luftfeuchtigkeit maßlich verändern. Verbindlich sind daher nur die Maßangaben.

▶ Vor der Verwendung Papierschablone maßlich kontrollieren und ggf. korrigieren.

The dimensions of the paper template can change depending on air humidity. For this reason, only our dimensional specifications are applicable.

▶ Before using the paper template check the dimensions and correct if necessary.

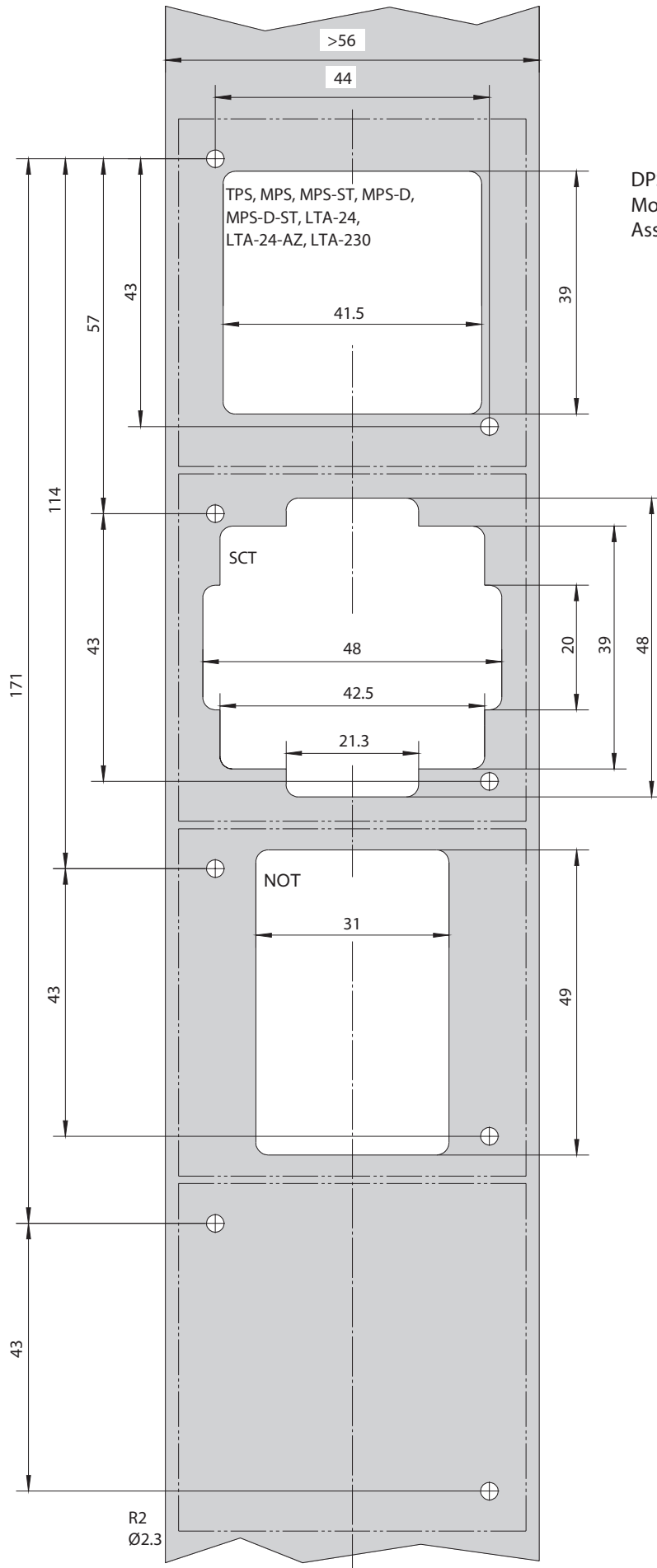

DPS, LTA-LSA:  
Montage in Pfosten nicht möglich. /  
Assembly on a post not possible.

# Schaltpläne / Circuit diagrams

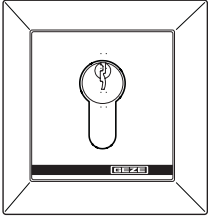
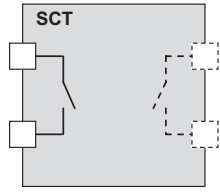
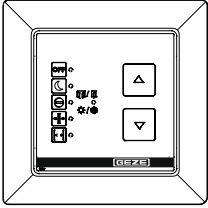
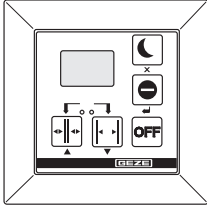
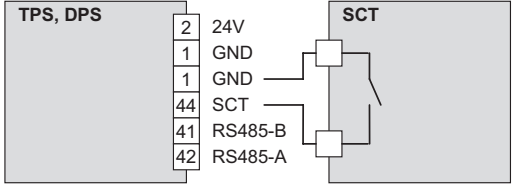
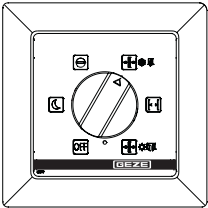
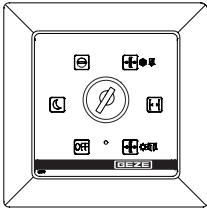
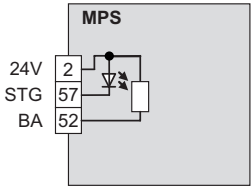
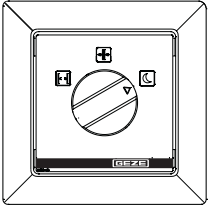
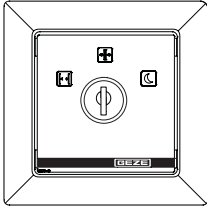
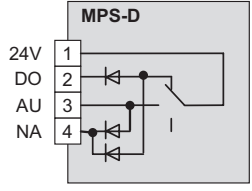
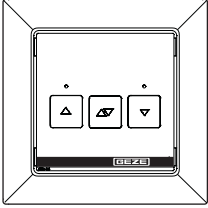
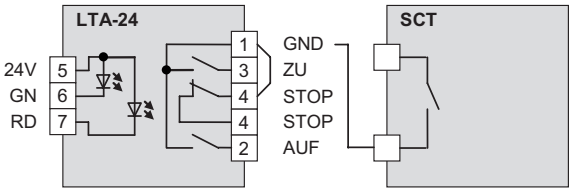
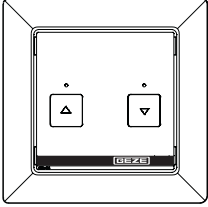
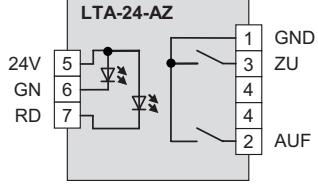
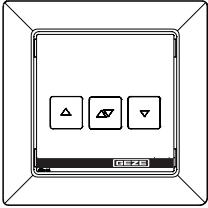
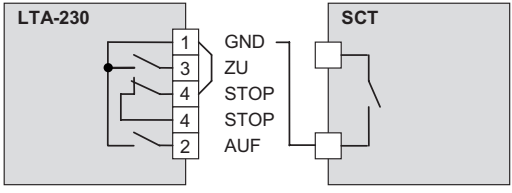
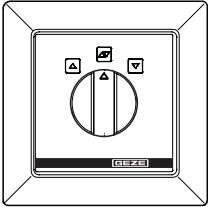
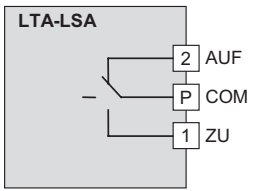
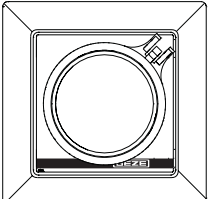
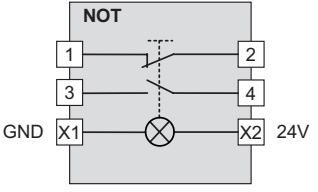
| Taster / Switches  | Bezeichnung / Description  | Mat. Nr. / Mat.No.   | Taster / Switches  | Bezeichnung / Description | Mat. Nr. / Mat. No. | Schaltplan / Circuit diagram  | h [mm] | t [mm] |
|--|--|--|--|---------------------------|---------------------|---|--------|--------|
|    | SCT (1-pol.)   | 117996   |  | -                         | -                   |    | 11     | 31.9   |
|    | TPS<br>TPS-SCT<br>TPS-KDT<br>TPS-KDT-SCT<br>DPS mit/with OFF<br>DPS ohne/without OFF<br>DPS mit/with OFF SCT | 113231<br>113232<br>126582<br>126583<br>151524<br>155809<br>155810 |   | TPS, DPS                  |                     |     | 11.3   | 5.3    |
|    | MPS  | 113226   |   | MPS-ST                    | 113227              |    | 24     | 36     |
|   | MPS-D  | 118417   |  | MPS-D-ST                  | 118418              |   | 24     | 36     |
|  | LTA-24<br>LTA-24-SCT   | 118473<br>127176   |  | LTA-24                    |                     |   | 11     | 26     |
|  | LTA-24-AZ  | 129393   |  | LTA-24-AZ                 |                     |  | 11     | 26     |
|  | LTA-230<br>LTA-230-SCT   | 118474<br>118475   |  | LTA-230                   |                     |   | 11     | 26     |
|  | LTA-LSA  | 118476   |  | LTA-LSA                   |                     |  | 24     | 32     |
|  | NOT  | 123132   |  | NOT                       |                     |  | 54     | 56     |