

Athmer - Fingerschutz® HS-25 | Door stop HS-25

2 BEDIENELEMENTE/2 OPERATING ELEMENTS

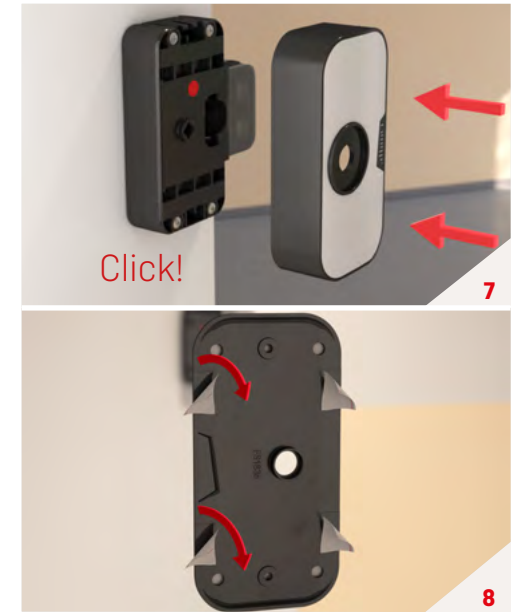

Technische Änderungen vorbehalten.
The right to make technical changes is reserved.

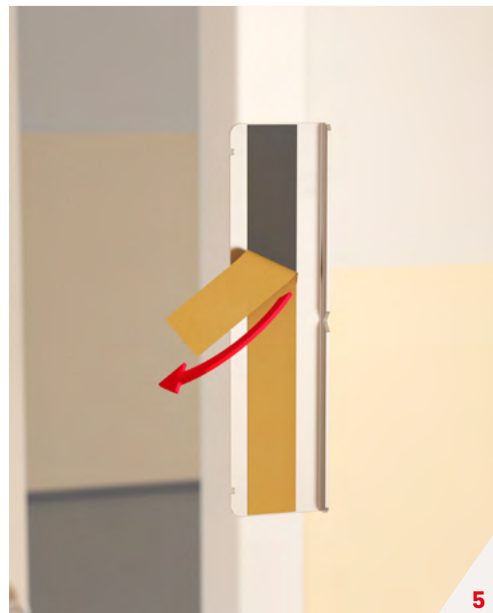
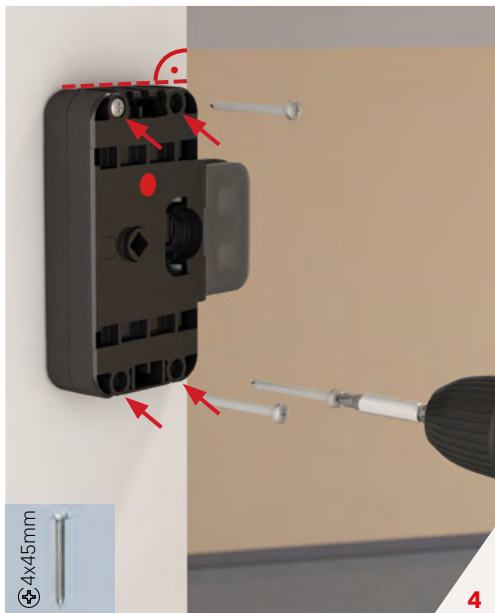
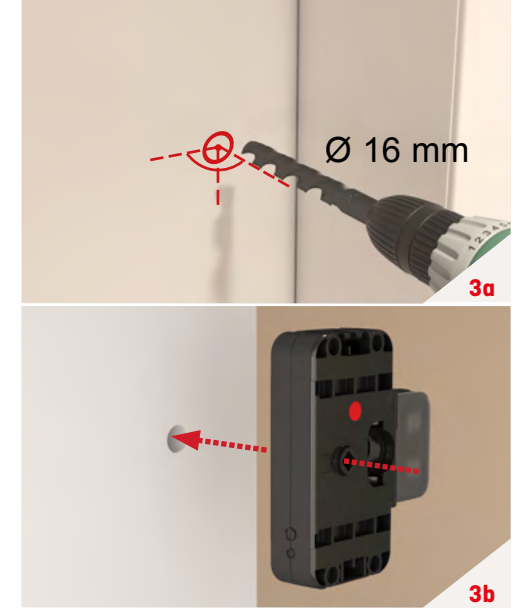
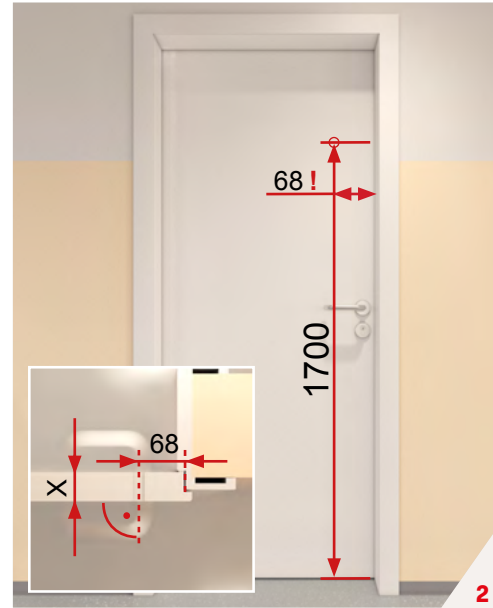
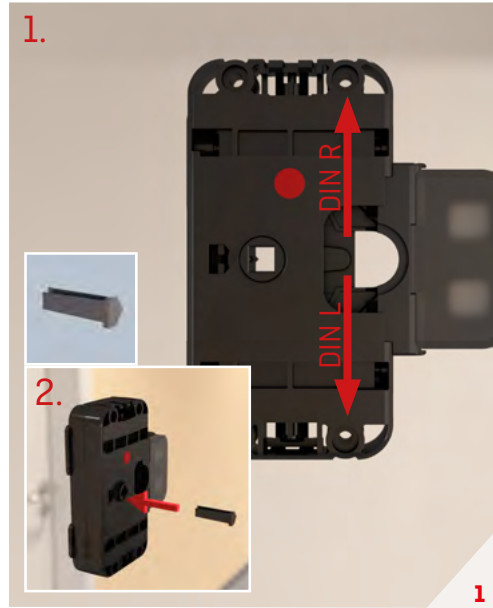

Produkt Video



Product video

Athmer - Fingerschutz® HS-25 | Door stop HS-25

2 BEDIENELEMENTE/2 OPERATING ELEMENTS

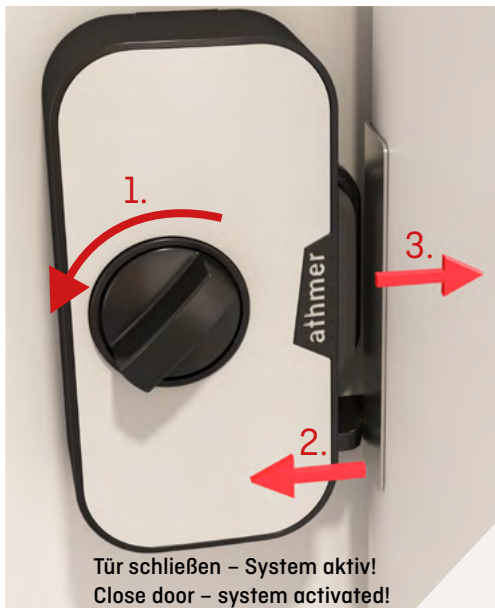
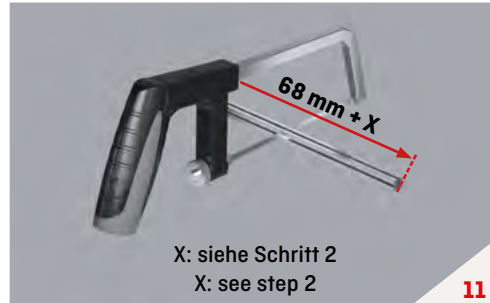
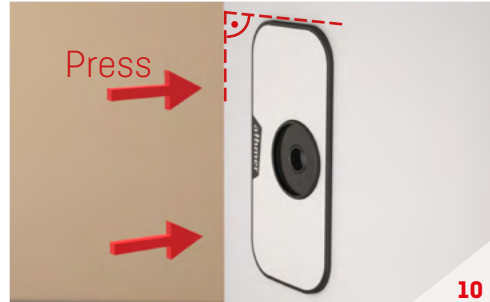

Produkt Video



Product video