

# BILOBA

## 8015JC



# INNER DOORS

# BILOBA

# 8015JC

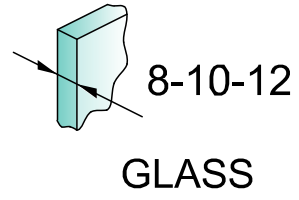
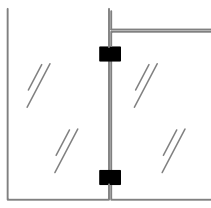
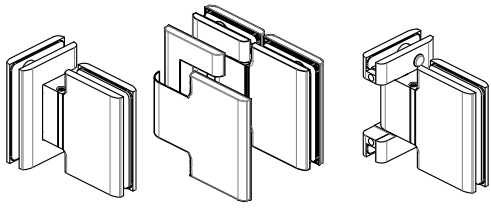

Tools required



## SEALS

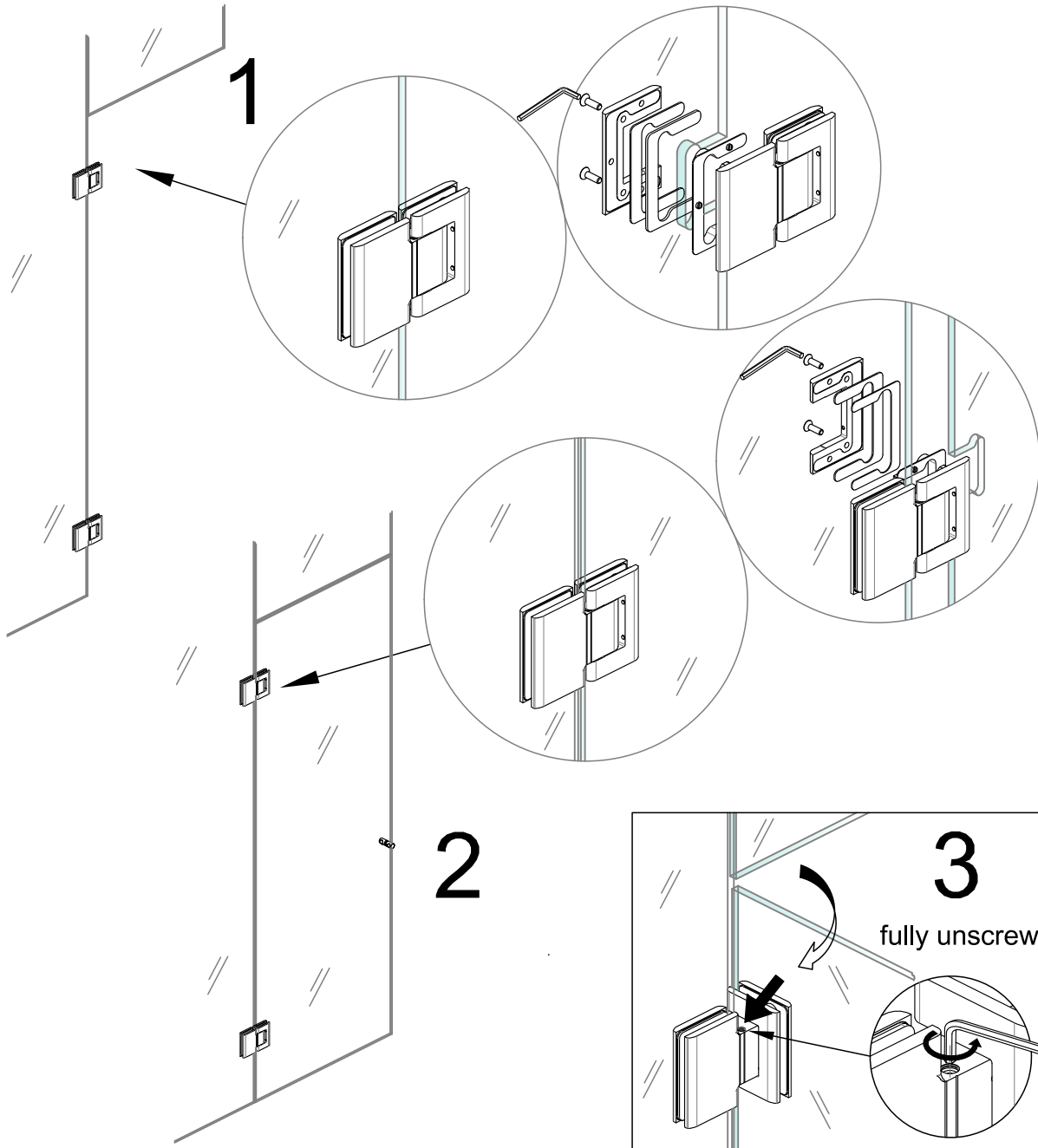
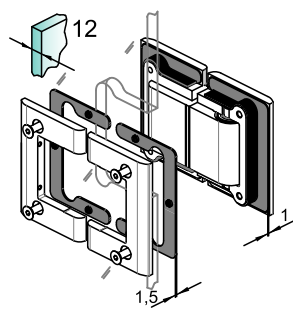
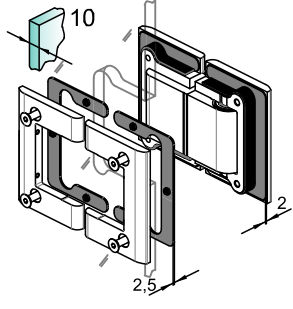
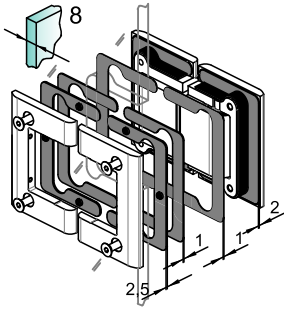

Horizontal alignment

7

(+) first REG

(-) first REG

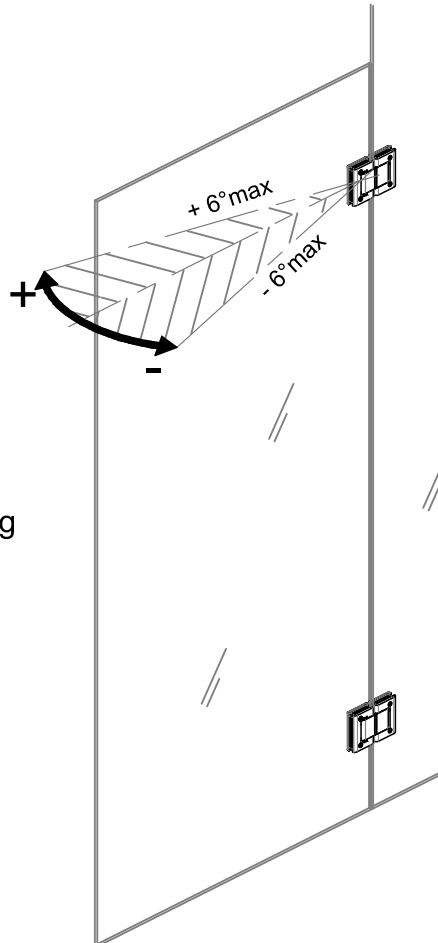
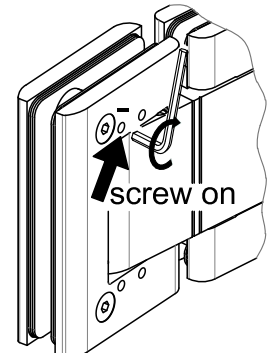
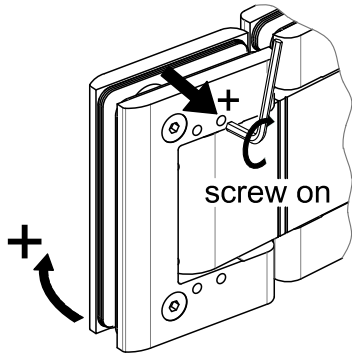

then, LOCK

then, LOCK

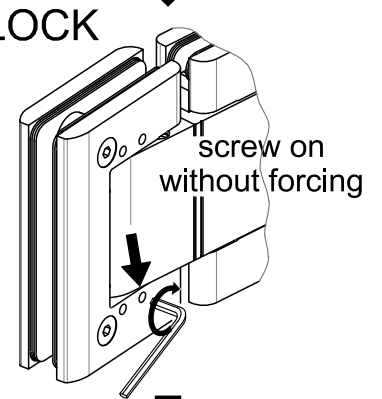
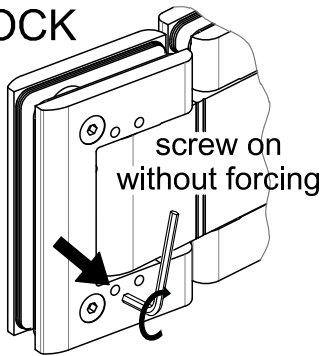

then, LOCK

then, LOCK

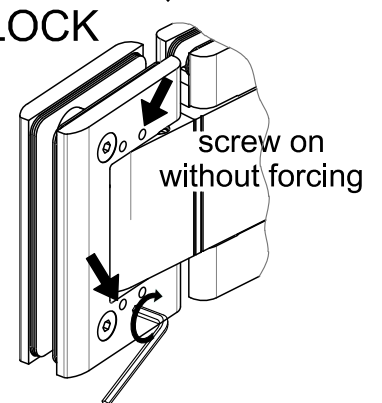
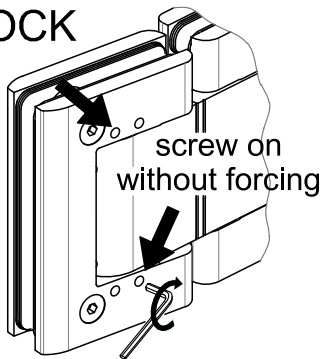

8

closing speed adjusting

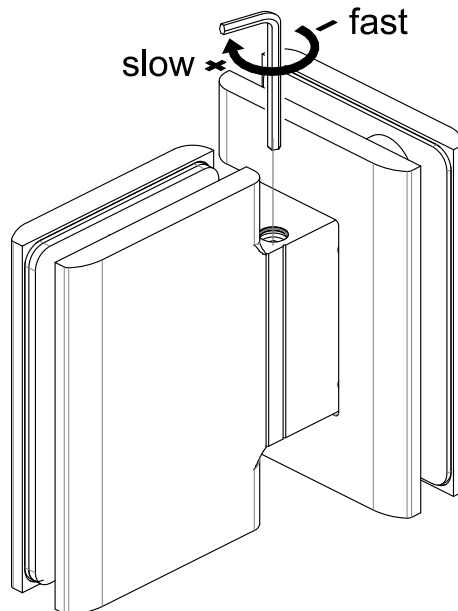

**IMPORTANTE: MONTARE COPERTINE SOLO DOPO AVER INSTALLATO LE CERNIERE**

## 1 MONTAGGIO COPERTINA CORPO

- A) APRIRE PORTA E CENTRARE COPERTINA SULLA BASE DEL CORPO INCLINANDOLA COME DA FIGURA
- B) RUOTARE LA COPERTINA E PREMERE CON FORZA ALLE DUE ESTREMITA FACENDO AGGANCIARE LA COPERTINA ALL'ALETTA TRAMITE GLI APPOSITI AGGANCI FINO A SENTIRE "CLICK"
- C) SPINGERE LA PARTE CURVA DELLA COPERTINA E FARE ACCOPIARE DENTINO CON APPOSITA SEDE. (VEDI IMMAGINE)

COPERTINA CORPO

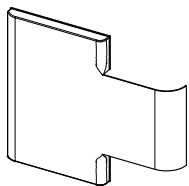

A

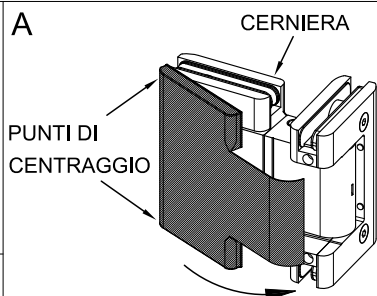

B PREMERE CON FORZA "CLICK"

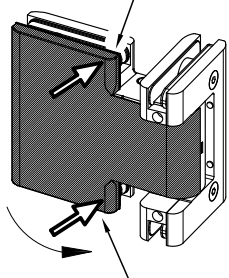

C

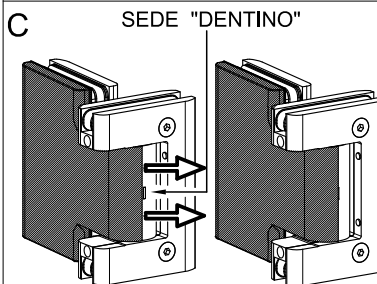

## 2 MONTAGGIO COPERTINA COPERCHIO

- A) CENTRARE COPERTINA COME DA IMMAGINE E RUOTARLA NELLA DIREZIONE INDICATA DALLA FRECCIA, PREMENDO CON FORZA FARE AGGANCIARE LA COPERTINA AL COPERCHIO TRAMITE GLI APPOSITI AGGANCI

COPERTINA COPERCHIO

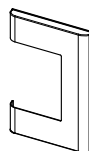

CERNIERA

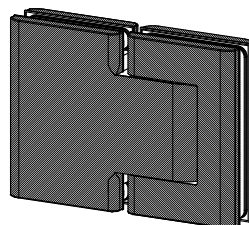

A

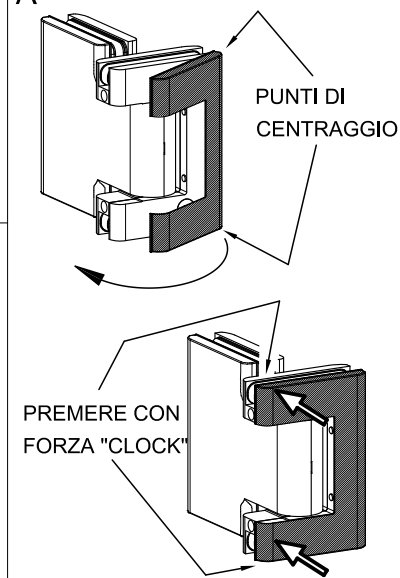

**N.B. RIPETERE LE STESSE OPERAZIONI PER LE COPERTINE SUL LATO OPPOSTO**

**MOUNT THE COVERS ONLY AFTER THE HINGES HAVE BEEN MOUNTED**

## 1 MOUNTING OF WING'S COVER

- A) OPEN THE DOOR AND CENTRE THE COVER ON THE WING'S BASE SLOPING IT AS SHOWN IN THE DRAWING.
- B) TURN THE COVER AND VIGOROUSLY PUSH AT BOTH ENDS; THE COVER SHALL HOOK ON THE WIN; A CLICK NOISE HAS TO BE HEARD.
- C) PUSH THE CURVED PART OF COVER AND ENTER THE LITTLE PIN IN THE APPROPRIATE SEAT (SEE DRAWING)

WING'S COVER

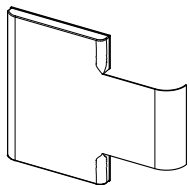

A

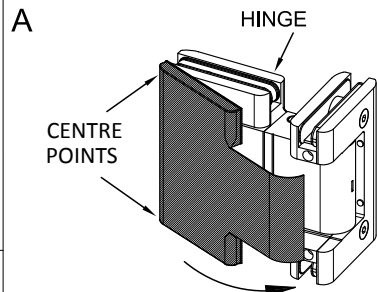

B VIGOROUSLY PUSH "CLICK"

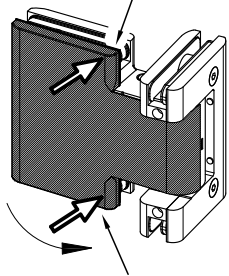

C

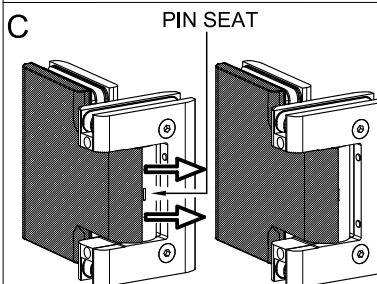

## 2 MOUNTING OF COVER PLATE'S COVER

- A) CENTRE THE COVER AS SHOWN IN THE DRAWING AND TURN IT IN THE DIRECTION INDICATED FROM THE ARROW. VIGOROUSLY PUSHING LET THE COVERS BE HOOKED ON THE COVER PLATE USING THE APPROPRIATE HOOKS.

COVER PLATE'S COVER

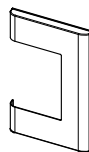

HINGE

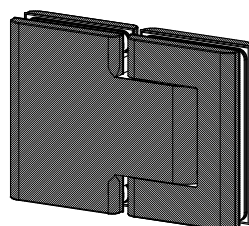

A

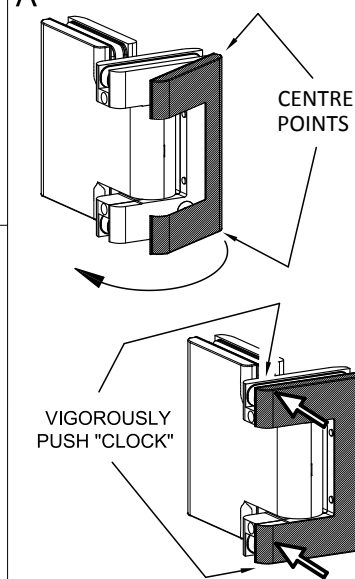

**N.B. REPEAT SAME STEPS FOR THE COVERS ON THE OPPOSITE SIDE**